



福建省长兴电子有限公司

CHANGXING ELECTRONICS CO., LTD.

福建省将乐县东门新村3号

NO.3 Dong Men New Village Jiangle Country, Fujian

电话: 86-598-2329554 传真: 86-598-2333554

石英晶体谐振器产品确认书

Quartz Crystal Resonator Specification For Approval

产品型号: Model	Seam3225 4PIN 20.000000MHz
客户名称: Customer	_____
客户编号: Customer's Part No.	_____
长兴编号: Product No.	8DSC200G0010L
发行日期: Issue Date	_____

承办: 吴丽萍

审核: 林东国

批准: 吕锡昌

内容:

- 1、Features 特点
- 2、Electrical Specifications 电气参数
- 3、Dimensions 外型尺寸
- 4、Marking 印码
- 5、Reflow Condition 回流焊条件
- 6、Packing 包装 (EIA-481-2)
- 7、Reliability Specifications 可靠性规范
- 8、Material Composition Declaration 产品物质成分表

客户 Conclusion:

Conditional Approval Full Approval Reject

会 签 意 见	
------------------	--

APPROVED BY :

ISSUED DATE :

3. 2x2.5x0.7mm SMD Seam Sealing Crystals / 8D Series

■ Features 特点

- . High precision and high frequency stability.
- . Extremely good for reducing EMI effect.
- . The best choice of Bluetooth, wireless communication set, DSC, PDA, and mobile phone.
- . RoHS Compliant / Pb Free.

■ Electrical Specifications 电气参数

Standard atmospheric conditions

Unless otherwise specified, the standard range of atmospheric conditions for making measurement and tests are as follow:

Ambient temperatu: $22 \pm 5^\circ\text{C}$

Relative humidity : 40%~70%

If there is any doubt about the results, measurement shall be made within the following limits:

Ambient temperatu: $22 \pm 1^\circ\text{C}$

Relative humidity : 40%~70%

Measure equipment

Electrical characteristics measured by HP E5100A or equivalent.

Crystal cutting type

The crystal is using AT CUT (thickness shear mode).

	Parameters	Electrical Spec.	UNITS	Notes
1	Nominal Frequency	20.000000	MHz	-
2	Oscillation Mode	Fund	-	-
3	Load Capacitance	10	pF	-
4	Frequency Tolerance	± 10	ppm	at $25^\circ\text{C} \pm 3^\circ\text{C}$
5	Frequency Stability	± 30	ppm	Over Operating Temp. Range
6	Operating Temperature	$-40 \sim +85$	$^\circ\text{C}$	-
7	Aging	± 3	ppm	1st Year
8	Drive Level	100	μW	-
9	Effective Resistance Rr	40 Max.	Ω	-
10	Shunt Capacitance C0	5 Max.	pF	-
11	Motional Capacitance C1	-	fF	-
12	Pulling Sensitivity TS	-	ppm/pF	-
13	Spurious Response	-3.0	dB	$-1000 \sim +5000$ ppm 125 步
14	Insulation Resistance	500 Min.	M Ω	at DC 100V
15	Storage Temperature Range	$-55 \sim +125$	$^\circ\text{C}$	-
16	RLD2	40 Max.	Ω	0.01~100 μW /Step 30
17	FDDL	10 Max.	ppm	
18	DLD2	10 Max.	Ω	
19	FDDLH	-	ppm	
20	DLDH2	-	Ω	
21	DLDF	-	Ω	
22	DLD2 (低)	-	Ω	-
23	MSL	Level 1	-	IPC/JEDEC J-STD-033C
24	Others	-	-	-

■ Dimensions外型尺寸

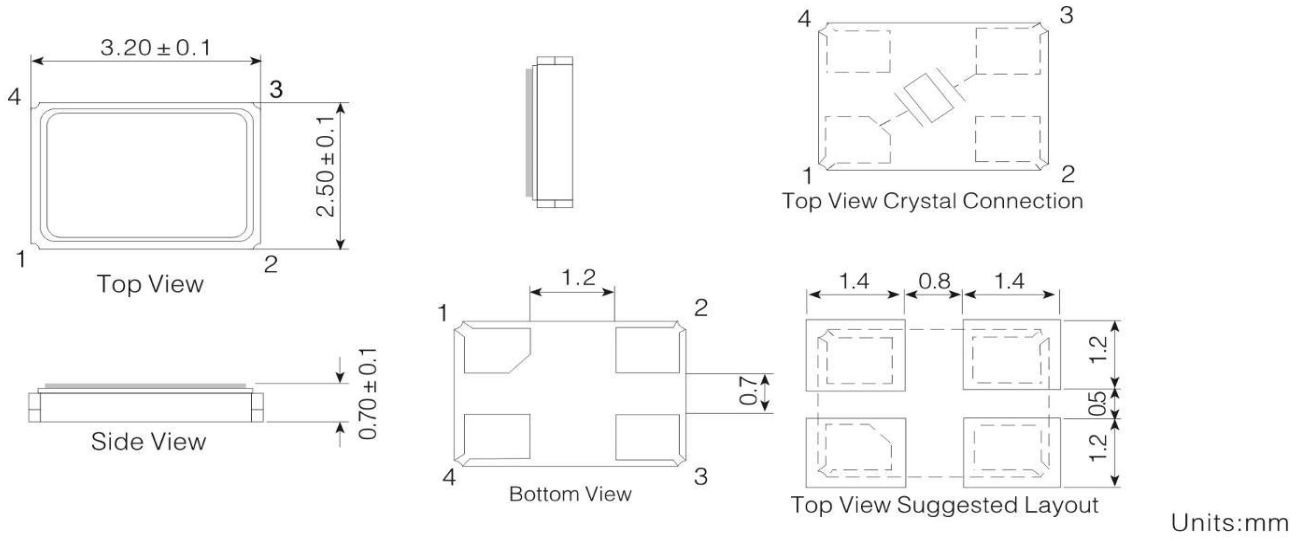

■ Marking印码

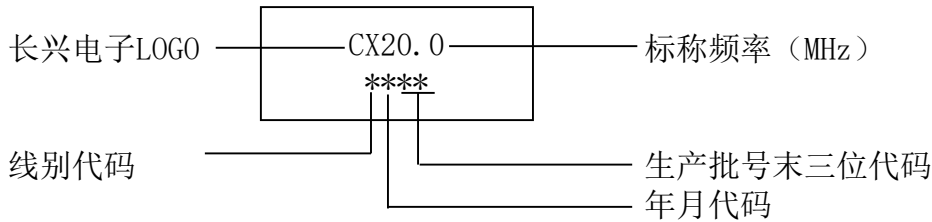

年月代码（四年一个周期）：

年份	月份												
	一月	二月	三月	四月	五月	六月	七月	八月	九月	十月	十一月	十二月	
2023	2027	a	b	c	d	e	f	g	h	j	k	l	m
2024	2028	n	p	q	r	s	t	u	v	w	x	y	z
2025	2029	A	B	C	D	E	F	G	H	J	K	L	M
2026	2030	N	P	Q	R	S	T	U	V	W	X	Y	Z

■ Reflow Condition回流焊条件

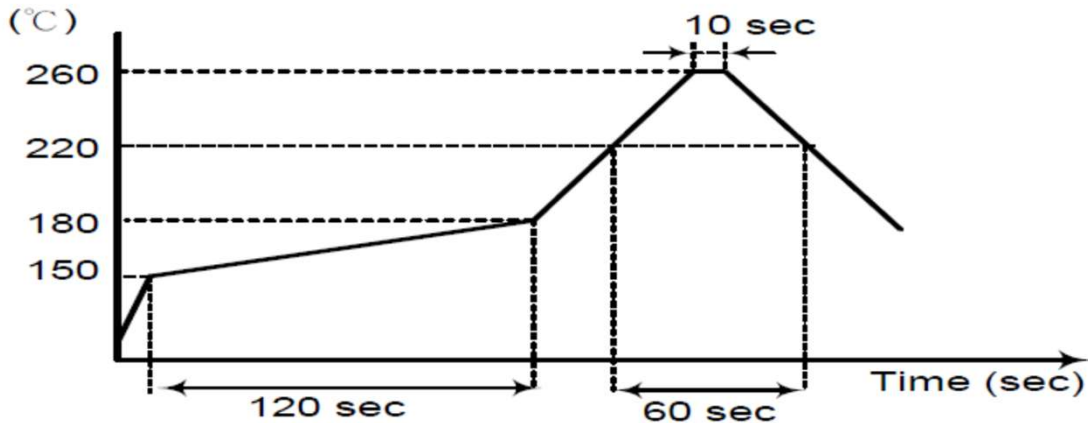

■ Packing包装 (EIA-481-2)

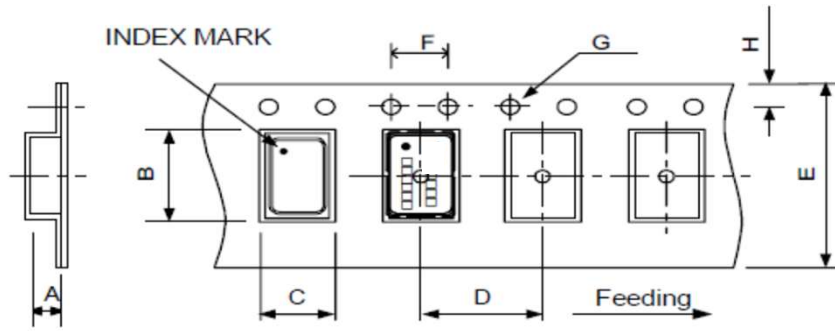

DIMENSIONS	A	B	C	D	E	F	G	H
UNIT : mm	1.40±0.1	3.40±0.1	2.70±0.1	4.00±0.1	8.0±0.2	4.00±0.1	1.55±0.05	1.75±0.1

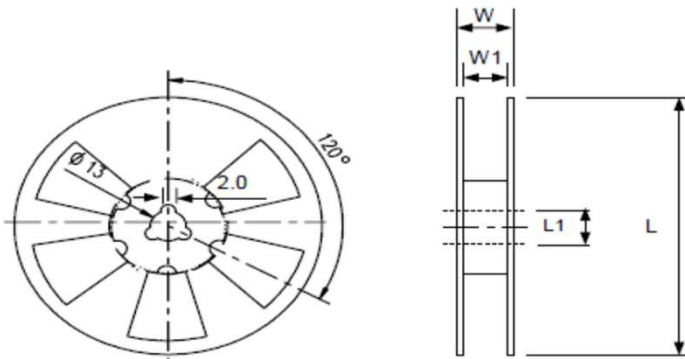
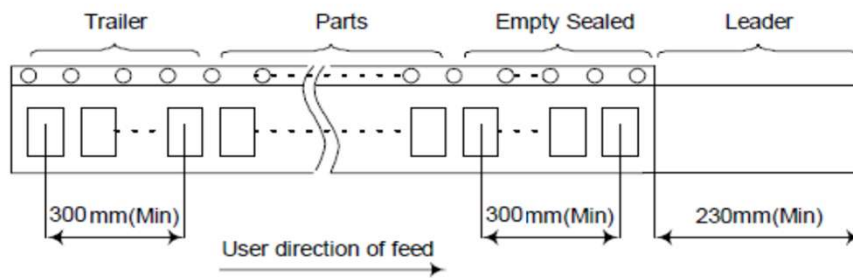

DIMENSIONS	L	L1	W	W1	Standard Reel Quantity
UNIT : mm	178±1.0	13±0.5	11.5±0.2	8.0±1.0	3,000 pcs per reel (WHITE)

■ Reliability Specifications (可靠性规范)

1. Mechanical Endurance (机械耐久性)

No.	Test Item	Test Methods	REF. DOC
1.1	Drop Test	150 cm height, 3 times on concrete floor .	JIS C6701
1.2	Shock Test	150g/150cm Height, 3 times in the direction of $\pm X, \pm Y, \pm Z$ on concrete floor	IEC-68-02-27
1.3	Mechanical Shock	Device are shocked to half sine wave (1000 G) three mutually perpendicular axes each 3 times. 0.5m sec. duration time	MIL-STD-202F
1.4	Vibration	Frequency range 10 ~ 2000 Hz Amplitude 1.52 mm/20G Sweep time 20 minute Perpendicular axes each test time 4 hours (Total test time 12 hours)	MIL-STD-883E
1.5	Gross Leak	Standard Sample For Automatic Gross Leak Detector, Test Pressure: 2Kg / cm ²	MIL-STD-883E
1.6	Fine Leak	Helium Bombing 4.5 Kgf / cm ² for 2 hr	
1.7	Solderability	Temperature 260 °C \pm 5°C Immersing depth 0.5 mm minimum Immersion time 5 \pm 1 seconds Flux Rosin resin methyl alcohol solvent (1 : 4)	MIL-STD-883E

2. Environmental Endurance (环境耐久性)

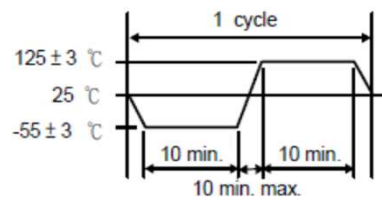
No.	Test Item	Test Methods	REF. DOC
2.1	Resistance To Soldering Heat	Pre-heat temperature 125 °C Pre-heat time 60 ~ 120 sec. Test temperature 260 \pm 5 °C Test time 10 \pm 1 sec.	MIL-STD-202F
2.2	High Temp. Storage	+ 125 °C \pm 3 °C for 500 \pm 12 hours	MIL-STD-883E
2.3	Low Temp. Storage	- 40 °C \pm 3 °C for 500 \pm 12 hours	
2.4	Thermal Shock	Total 100 cycles of the following temperature cycle 	MIL-STD-883E
2.5	High Temp & Humidity	85°C \pm 3°C , RH 85% , 500Hrs	JIS C5023
2.6	Pressure Cooker Storage	125°C \pm 3°C , RH100% , 2 bar , 240Hrs	JIS C6701

Material Composition Declaration

材料成份表

1.PRODUCTION NAME : Seam 3225

2.PRODUCTION WEIGHT(mg) : 17.322

编号 No.	构成部件 Name of Part	部件材质名 Material Name	材质质量 Material Mass(mg)	材质质量百分比 Material mass (%)	构成之元素名称 Constituent name	CAS编号 CAS No.	元素百分比 Material Analysis(%)
1	基座 Base	陶瓷 Ceramics	6.40	36.95%	Al ₂ O ₃ Aluminum oxide	1344-28-1	92.40%
					SiO ₂ Siliconoxide	7631-86-9	4.31%
					Cr ₂ O ₃	1308-38-9	1.50%
					MgO Magnesium oxide	1309-48-4	0.69%
					CaO Calcium oxide	1305-78-8	1.10%
		KV环	2.60	15.01%	Fe Iron	7439-89-6	40.70%
					Ni Nickel	7440-02-0	21.80%
					Co	7440-48-4	12.80%
		焊料	2.60	15.01%	Ag silver	7440-22-4	21.00%
					Cu	7440-50-8	3.70%
		金属化 (Metal)	4.00	23.09%	W Tungsten	7440-33-7	100.00%
					镀层 Metallizing	4.00	23.09%
				Ni Nickel	7440-02-0	100.00%	
2	外壳 Cover	4J29 (基材)	3.62	20.91%	Fe	7439-89-6	53.45%
					Ni	7440-02-0	29.25%
		Co			7440-48-4	17.30%	
		Ni (镀层)			7440-02-0	100.00%	
3	黏合剂 Adhesive	金属 Metal	0.20	1.15%	Ag Silver	7440-22-4	75.00%
		聚合物 Polymer			C ₁₁ H ₂₄ Undecane	1120-21-4	5.00%
					C ₁₂ H ₂₆ Dodecane	112-40-3	5.00%
					Silicone resin	-	15.00%
4	Blank	晶片 Quartz	0.45	2.60%	SiO ₂ Silicon oxide	14808-60-7	100.00%
5	Electrode	电极 Electrode	0.05	0.29%	Cr Chromium	7440-47-3	5.56%
					Ag silver	7440-22-4	94.44%