

	惠州精勤电子元件有限公司	FILE NO.	QC-T4-09
	Huizhou Jingqin Electronic Components Co.LTD	Ver:	1.0
	贴片安规 Y 电容 (SMD-Y-CAP)	Page	1/21

产品承认书

SPECIFICATION FOR APPROVAL

客户名称 CUSTOMER	_____
客户料号 PART NO	_____
规格描述 DESCRIPTION	见第 6-8 页
精勤料号 JingQin P/N	见第 6-8 页
日期 DATE	_____

Huizhou Jingqin Electronic Components Co., Ltd		
Made By	Checked By	Approval By

Customer Approval		
Prepared By	Checked By	Approval By

 精勤元件	惠州精勤电子元件有限公司	FILE NO.	QC-T4-09
	Huizhou Jingqin Electronic Components Co.LTD	Ver:	1.0
	贴片安规 Y 电容 (SMD-Y-CAP)	Page	3/21

目录 Table of Contents

No.	项目 (Item)	页次 (Page)
1	规格书版本变更记录 (COMPONENT SPEC VERSION RECORD)	3
2	产品特性	4
3	品名说明 (Part No. Explain)	5
4	规格明细及尺寸 (Specification details & dimensions)	6
5	标印说明 (Marking Explain)	10
6	安规认证 (Safety Certification)	10
7	结构说明 (Structure)	10
8	特性标准及测试方法 (Specification and test method)	11~16
9	温度特性 (Temperature characteristic)	16
9	包装说明 (packing description)	17-18
10	焊接说明 Welding according to the instruction	18
11	注意事项 HANDLING PRECAUTIONS FOR CERAMIC CAPACITORS	19~21

	惠州精勤电子元件有限公司	FILE NO.	QC-T4-09
	Huizhou Jingqin Electronic Components Co.LTD	Ver:	1.0
	贴片安规 Y 电容 (SMD-Y-CAP)	Page	4/21

COMPONENT SPEC VERSION RECORD

VER	MINUTE OF CHANGES	SEC CHECK	RELEASE DATE
1.0	CHECKED AND RELEASED	张婉	2022/06/01

	惠州精勤电子元件有限公司 Huizhou Jingqin Electronic Components Co.LTD	FILE NO.	QC-T4-09
	贴片安规 Y 电容 (SMD-Y·CAP)	Ver:	1.0
		Page	5/21

--	--	--	--

■ **产品特性 Features**

1、 **特点 Feature**

1.1 先进的封装工艺，封装材料满足 UL94-V0

Advanced packaging technology, packaging materials meet UL94-V0

	惠州精勤电子元件有限公司 Huizhou Jingqin Electronic Components Co.LTD	FILE NO.	QC-T4-09
	贴片安规 Y 电容 (SMD-Y-CAP)	Ver:	1.0
		Page	6/21

1.2 结构紧凑，体积小，节省空间

Compact structure, small size, space saving

1.3 优越的高温高湿性能

Superior high temperature and high humidity performance

1.4 强大的耐电压能力

Strong voltage resistance

1.5 SMD 料盘包装，适用于无铅回流焊/波峰焊自动贴装

SMD tray packaging, suitable for lead-free reflow soldering/wave soldering automatic placement 1.6 符合 RoSH , REACH , H.F 无卤

Comply with RoSH, REACH, H.F

1.7 安规认证: Safety certification:

1.8 管理体系认证: ISO9001:2015 质量管理体系 ISO9001:2015 Quality Management System ISO14001:2015 环境管理体系 ISO14001:2015 Environmental Management System IAFT16949 汽车行业质量管理体系 IAFT16949 Automotive Quality Management System



2、应用 Application

2.1 LED circuit protection LED 电路保护

2.2 Industrial equipment 工业设备

2.3 Communication equipment 通讯设备

2.4 Automotive Electronics 汽车电子

■测试条件 Test Condition

工作温度: -40°C ~ 125°C

储存温度: -10°C ~ 40°C

一. 品名说明 (Part No.Explain)

	惠州精勤电子元件有限公司	FILE NO.	QC-T4-09
	Huizhou Jingqin Electronic Components Co.LTD	Ver:	1.0
	贴片安规 Y 电容 (SMD-Y-CAP)	Page	7/21

SMD-2 Y1X1 Y5U 102 M 500VAC A P
 ① ② ③ ④ ⑤ ⑥ ⑦ ⑧ ⑨

序号	代码	表示说明
①	SMD	塑封贴片型
②	3	1 代表: 1 个 Y1 电容 2 代表: 2 个 Y1 电容串联 双 Y 专利号: ZL 2021 2 0745266.4 3 代表: 2 个 Y1 电容并联 专利号: ZL 2021 2 1194394.0
③	Y1X1	安规等级
④	Y5P	容量温度特性: SL: +350~-1000ppm/°C, Y5P: ±10%, Y5U: (+ 22% ~ -56%) , Y5V: (+ 30% ~ -82%)
⑤	102	标称静电容量: 102=10 x 10 ² =1000pF
⑥	K	静电电容公差: J:±5%, K: ±10% , M: ±20%
⑦	500V AC	额定交流电压
⑧	C	内部管理码 (可自定义)
⑨	P	内部管理码 (可自定义)

二、规格明细及尺寸(Specification details & dimensions)

 精勤元件	惠州精勤电子元件有限公司 Huizhou Jingqin Electronic Components Co.LTD	FILE NO.	QC-T4-09
	贴片安规 Y 电容 (SMD-Y-CAP)	Ver:	1.0
		Page	8/21

2.1 规格列表:

材质	标称容量 (pF)	规格型号
Y5P	100	SMD-2Y1X1Y5P101K500VAC 双 Y
Y5P	110	SMD-2Y1X1Y5P111K500VAC 双 Y
Y5P	120	SMD-2Y1X1Y5P121K500VAC 双 Y
Y5P	150	SMD-2Y1X1Y5P151K500VAC 双 Y
Y5P	160	SMD-2Y1X1Y5P161K500VAC 双 Y
Y5P	180	SMD-2Y1X1Y5P181K500VAC 双 Y
Y5P	200	SMD-2Y1X1Y5P201K500VAC 双 Y
Y5P	220	SMD-2Y1X1Y5P221K500VAC 双 Y
Y5P	230	SMD-2Y1X1Y5P231K500VAC 双 Y
Y5P	270	SMD-2Y1X1Y5P271K500VAC 双 Y
Y5P	280	SMD-2Y1X1Y5P281K500VAC 双 Y
Y5P	310	SMD-2Y1X1Y5P311K500VAC 双 Y
Y5P	330	SMD-2Y1X1Y5P331K500VAC 双 Y
Y5P	340	SMD-2Y1X1Y5P341K500VAC 双 Y
Y5P	390	SMD-2Y1X1Y5P391K500VAC 双 Y
Y5P	410	SMD-2Y1X1Y5P411K500VAC 双 Y
Y5P	470	SMD-2Y1X1Y5P471K500VAC 双 Y

 精勤元件	惠州精勤电子元件有限公司 Huizhou Jingqin Electronic Components Co.LTD		FILE NO.	QC-T4-09
	贴片安规 Y 电容 (SMD-Y·CAP)		Ver:	1.0
			Page	9/21

Y5U	240	SMD-2Y1X1Y5U241M500VAC	双 Y
Y5U	340	SMD-2Y1X1Y5U341M500VAC	双 Y
Y5U	410	SMD-2Y1X1Y5U411M500VAC	双 Y
Y5U	470	SMD-2Y1X1Y5U471M500VAC	双 Y
Y5U	500	SMD-2Y1X1Y5U501M500VAC	双 Y
Y5U	680	SMD-2Y1X1Y5U681M500VAC	双 Y
Y5U	750	SMD-2Y1X1Y5U751M500VAC	双 Y
Y5U	820	SMD-2Y1X1Y5U821M500VAC	双 Y
Y5U	1000	SMD-2Y1X1Y5U102M500VAC	双 Y
Y5V	1000	SMD-2Y1X1Y5V102M500VAC	双 Y
Y5V	1500	SMD-2Y1X1Y5V152M500VAC	双 Y
Y5V	2200	SMD-2Y1X1Y5V222M500VAC	双 Y

2.2.外观尺寸:

(单位 mm)

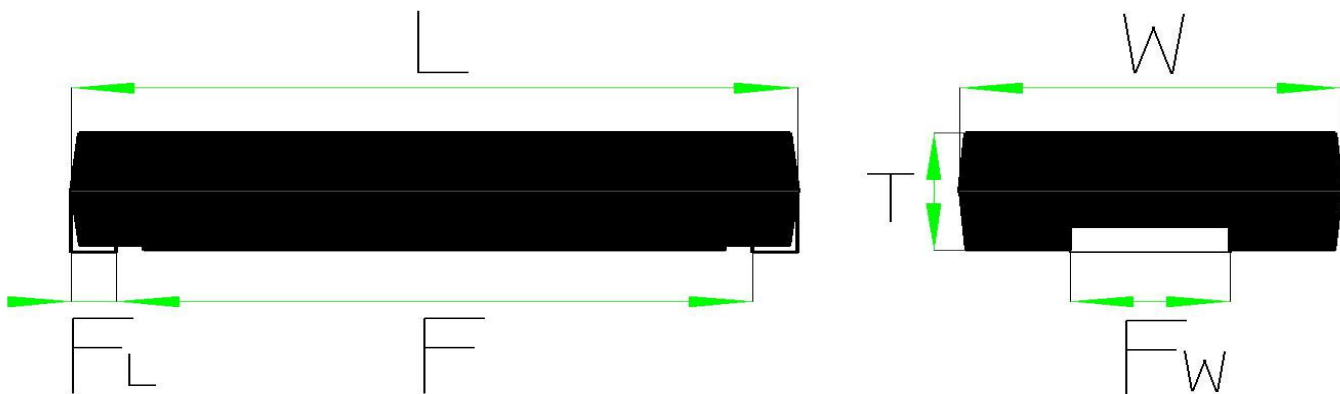

规格	L	W	T	F	FL	FW
500VAC	11.4±0.3	6.0±0.3	2.4±0.1	10±0.3	0.7±0.3	2.5±0.3

2.3 焊盘尺寸:

(单位 mm)

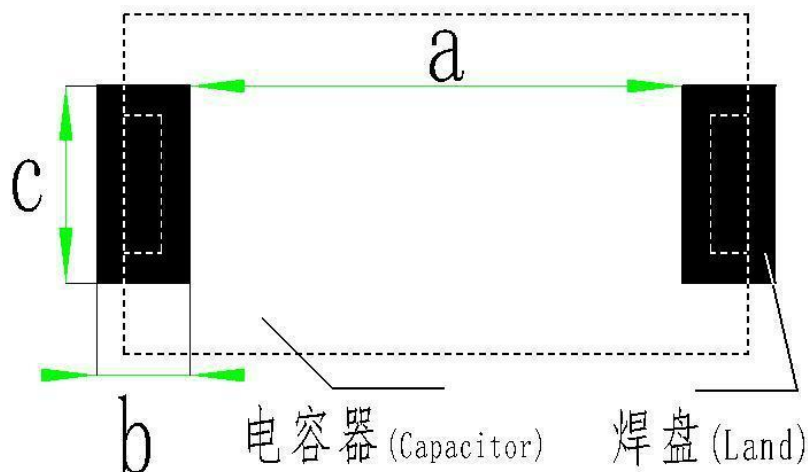

 精勤元件	惠州精勤电子元件有限公司 Huizhou Jingqin Electronic Components Co.LTD	FILE NO.	QC-T4-09
		Ver:	1.0
	贴片安规 Y 电容 (SMD-Y-CAP)	Page	11/21

尺寸(4524)	a	b	C
11.4x6.0	9	1.7	3.6

	惠州精勤电子元件有限公司	FILE NO.	QC-T4-09
	Huizhou Jingqin Electronic Components Co.LTD	Ver:	1.0
	贴片安规 Y 电容 (SMD-Y·CAP)	Page	12/21

三、标印说明 (Marking Explain)

	JING LIN : 精勤品牌LOGO
	SMD: 塑封贴片型
	2:2个Y1电容串联;1:1个Y1电容;3:2个Y1电容并联
	Y1X1: 安规等级
	Y5U: 温度特性
	222: 标称静电容量 $22 \times 10^2 = 2200 \text{pF}$
	M: $\pm 20\%$; K: $\pm 10\%$; J: $\pm 5\%$
	C3BDARP: 内部批次追溯码
250/500V~: 额定交流电压	

四、安全认证 Safety Certification:

CUL No: E529031

CQC No: CQC22001350036

ENEC No: ENEC-04145

KC No: SU03131-22001

CB No: CN57354

五、产品结构图 Structure

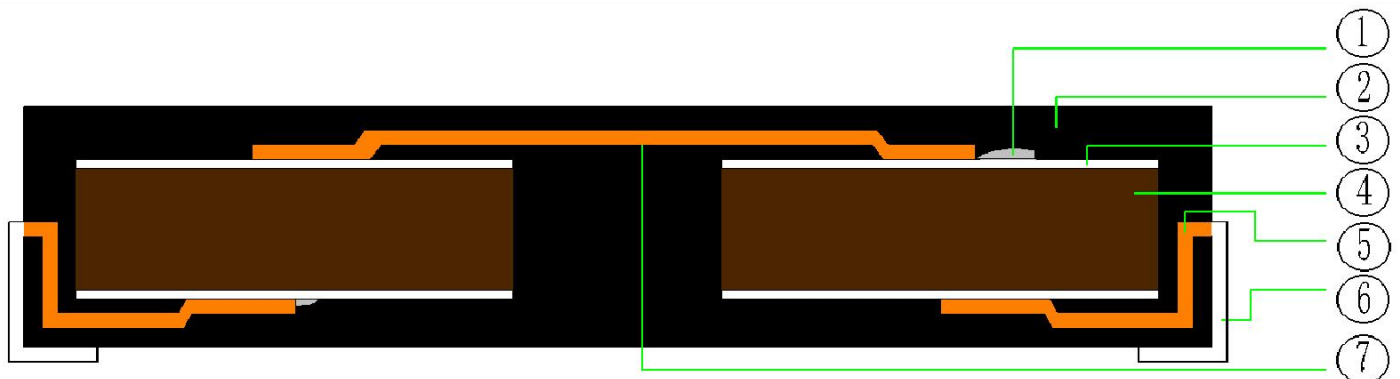

	惠州精勤电子元件有限公司 Huizhou Jingqin Electronic Components Co.LTD	FILE NO.	QC-T4-09
	贴片安规 Y 电容 (SMD-Y-CAP)	Ver:	1.0
		Page	13/21

六、特性标准及测试方法 (Specification and test method) :

NO	项目 ITEMS	判定标准 PERFORMANCE	试验方法 TESTING METHOD												
1	工作温度范围 Operation Temperature	-40℃~+125℃	/												
2	外观尺寸检查 (Appearance and dimension)	组件表面清洁, 无异物附着无可见损伤, 尺寸符合规定要求 (Clean surface, no visible damage. Dimension according to ordain requirement)	目视检外观 Visual check of Appearance 用卡尺测量尺寸 Measure the size with vernier caliper.												
3	标志 marking	The marking shall be easily legible	用目测法观测 Visual check												
4	静电容量 (Capacitance)	在允许的偏差等级范围内 To be within the specified tolerance.	环境温度 (Temperature) 20℃±2℃:												
5	质量因素或损失角 (Quality Factor or Dissipation Factor)	Y5P/Y5U	测量频率 (Test Frequency) : 1KHz±20% (SL/DL:1MHz±20%)												
		SL	测量电压(Test Voltage): 5Vrms max												
6	绝缘电阻 (Insulation Resistance)	≥10000MΩ	测量电压 (Test Voltage) :DC500V 充电时间 (Test Time) : 60±5s.												
7	端子间 Between Lead Wires	无失效 No breakdown	在电容两端子间施加下表所要求的电压保持 60 秒 The capacitor should not be damaged when the test voltages from Table 1 are applied between the lead wires 60 sec. <table border="1" style="margin-left: 20px;"> <tr> <th>Table 1</th> <th>Type</th> <th>Test Voitage</th> </tr> <tr> <td></td> <td>X1/Y1</td> <td>AC4000V</td> </tr> </table>	Table 1	Type	Test Voitage		X1/Y1	AC4000V						
	Table 1	Type	Test Voitage												
	X1/Y1	AC4000V													
端子与外壳间 Body Insulation	无失效 No breakdown	将电容器的引线连在一起, 主体外紧包一层 铝箔, 边沿距引线 4-6mm, 在电容器引线和 铝箔间施加上表 1 电压一分钟。(First, the terminals of the capacitor should be connected together, and the capacitor should be wrapped closely with an aluminum film around the body of the capacitor to a distance about 2 to 3mm from each terminal. Then, put the capacitor into the testing jig as shown in below figure. Finally, apply a voltage of Table 2 for 60 sec)													
8	温度特性 (Temperature Characteristics)	Y5P	±10%												
		Y5U	-56% ~ +22%												
			依表 1 中各温度段进行容量测试, 并计算出变化率(he capacitance measurement shall be made at each step specified in table 1) TABLE 1 <table border="1" style="margin-left: 20px;"> <thead> <tr> <th>STEP</th> <th>TEMPERATURE</th> </tr> </thead> <tbody> <tr> <td>1</td> <td>+20±2℃</td> </tr> <tr> <td>2</td> <td>-25±2℃</td> </tr> <tr> <td>3</td> <td>+20±2℃</td> </tr> <tr> <td>4</td> <td>+85±2℃</td> </tr> <tr> <td>5</td> <td>+20±2℃</td> </tr> </tbody> </table> SB/SE: TC= (C2-C1)/C1×100%	STEP	TEMPERATURE	1	+20±2℃	2	-25±2℃	3	+20±2℃	4	+85±2℃	5	+20±2℃
STEP	TEMPERATURE														
1	+20±2℃														
2	-25±2℃														
3	+20±2℃														
4	+85±2℃														
5	+20±2℃														

	惠州精勤电子元件有限公司		FILE NO.	QC-T4-09
	Huizhou Jingqin Electronic Components Co.LTD		Ver:	1.0
	贴片安规 Y 电容 (SMD-Y-CAP)		Page	14/21

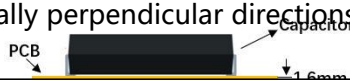
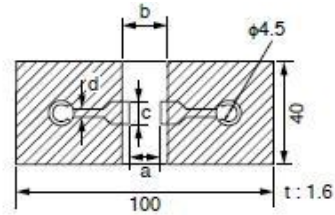
			Y5V	-82% ~ +30%	SL: $TC(PPM/^{\circ}C) = [(C2-C1) * 10^6] / [C1(T2-T1)]$ C1 : Capacitance at standard temperature (20^{\circ}C). C2 : Capacitance at each temperature. T1: Test temperature (Min. Temp. and Max. Temp.) T2: Reference temperature											
			SL	+350~-1000PPM/ ^{\circ}C (+20~85^{\circ}C)												
9	耐振性 (Vibration Resistance)	外观 (Appearance)	外观 Appearance	无显着异常(No marked defect)	将电容器焊接在测试夹具上，并经如下振动频率 10Hz-55Hz-10Hz 全振幅 1.5mm，1 分钟内完全重复振动。此试验如无特别规定应在彼此互相成垂直的方向各操作 2 小时(合计 6 小时)后检查电容器有无机械损伤。 Solder the capacitor to the test jig (glass epoxy board).The capacitor should be subjected to a simple harmonic motion having a total amplitude of 1.5mm, the frequency being varied uniformly between the approximate limits of 10 to 55Hz.The frequency range, from 10 to 55Hz and return to 10Hz, should be traversed in approximately 1min.This motion should be applied for a period of 2hrs.in each of 3 mutually perpendicular directions (total of 6hrs.). 											
			容量 Capacitance	Within the specified tolerance												
			D.F./Q	Within the specified tolerance												
10	可焊性 (Solderability of leads)	焊料分布均匀,覆盖周边 75%区域 (75% of the terminations are to be soldered evenly and continuously.)			电容器引线进入 25%的酒精松香焊剂后，浸入温度为 245^{\circ}C \pm 5^{\circ}C (Sn-3.0Ag-0.50u)的熔锡内 2s \pm 0.5s，浸入速度 25 \pm 2.5mm/s。 Immerse the capacitor in a solution of ethanol (JIS-K-8101) and rosin (JIS-K-5902) (25% rosin in weight proportion). Immerse in solder solution for 2 \pm 0.5 sec ,Immersing speed: 25 \pm 2.5mm/s Temp. of solder: 245 \pm 5^{\circ}C Lead Free Solder (Sn-3.0Ag-0.5Cu)											
11	弯曲 (Deflection)	无显着异常 No marked defect  <table border="1" style="margin-top: 10px;"> <thead> <tr> <th colspan="4">Dimension(mm)</th> </tr> </thead> <tbody> <tr> <td>a</td> <td>b</td> <td>c</td> <td>d</td> </tr> <tr> <td>9.6</td> <td>11.7</td> <td>2.7</td> <td>1.0</td> </tr> </tbody> </table>	Dimension(mm)				a	b	c	d	9.6	11.7	2.7	1.0		将电容器焊接在图一所示的测试夹具上，施加图一所示的测试力;电容器应采用回流焊法焊接，并进行护理，以保证电容器不会受热冲击等破坏 Solder the capacitor to the test jig(glass epoxy board)shown in Fig.1; Then apply a force in the direction shown in Fig.1. The soldering should be done using reflow method and should be conducted with care so that the soldering is uniform a free of defects such as heat shock. Fig.1
Dimension(mm)																
a	b	c	d													
9.6	11.7	2.7	1.0													

	惠州精勤电子元件有限公司		FILE NO.	QC-T4-09
	Huizhou Jingqin Electronic Components Co.LTD		Ver:	1.0
	贴片安规 Y 电容 (SMD-Y-CAP)		Page	15/21

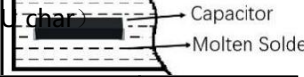
12	焊接强度 (Adhesive Strength of Termination)	引脚无偏移或发生其他不良 (No removal of the terminations or other defect should occur.)		<p>将电容器焊接在图 2 所示的测试夹具上，施加箭头所示方向的 10N 推力;电容器应采用回流焊法焊接，并应进行护理，以保证电容器不会受热冲击等破坏.Solder the capacitor to the test jig(glass epoxy board)shown in Fig.2; Then apply 10N force in the direction of the arrow. The soldering should be done using reflow method and should be conducted with care so that the soldering is uniform and free of defects such as heat shock.</p>																									
13	耐焊接热 (Resistance to Soldering Heat)	<table border="1"> <tr> <td>外观 Appearance</td> <td colspan="2">无显着异常 No marked defect</td> </tr> <tr> <td rowspan="3">容量变化 Capacitance Change</td> <td>SL</td> <td>±5%</td> </tr> <tr> <td>Y5P</td> <td>±10%</td> </tr> <tr> <td>Y5U</td> <td>±20%</td> </tr> <tr> <td>绝缘电阻 I.R.</td> <td colspan="2">1000MΩ min</td> </tr> </table>	外观 Appearance	无显着异常 No marked defect		容量变化 Capacitance Change	SL	±5%	Y5P	±10%	Y5U	±20%	绝缘电阻 I.R.	1000MΩ min		<table border="1"> <tr> <td>耐电压 Dielectric Strength</td> <td colspan="2">参考项目 7 Per Item 7.</td> </tr> </table>	耐电压 Dielectric Strength	参考项目 7 Per Item 7.		<p>预处理：产品在 150 +0/-10℃下放置 60±5 分钟，然后在室温下放置 24±2h (B/E 材质适用)。按下表方法进行预处理后，将电容器浸入 260+5℃熔锡中 10±1 秒，浸入速度 25±2.5mm/s，在室温下放置 24±2h 后测试。</p> <p>Preheat the capacitor as in table. Immerse the capacitor in solder solution at 260±5℃for 10±1 sec. Let sit at room condition for 24±2 hrs., then measured.</p> <p>Immersing speed: 25±2.5mm/s</p> <p>Pretreatment: Perform a heat treatment at 150 +0/-10℃ for 60±5 min. and then let sit for 24±2 hrs. at room condition (for Y5P、Y5U character)</p> <div style="text-align: center;">  </div> <table border="1"> <thead> <tr> <th>Step</th> <th>Temperature</th> <th>Time</th> </tr> </thead> <tbody> <tr> <td>1</td> <td>100 to 120℃</td> <td>1 min.</td> </tr> <tr> <td>2</td> <td>170 to 200℃</td> <td>1 min.</td> </tr> </tbody> </table>	Step	Temperature	Time	1	100 to 120℃	1 min.	2	170 to 200℃	1 min.
外观 Appearance	无显着异常 No marked defect																												
容量变化 Capacitance Change	SL	±5%																											
	Y5P	±10%																											
	Y5U	±20%																											
绝缘电阻 I.R.	1000MΩ min																												
耐电压 Dielectric Strength	参考项目 7 Per Item 7.																												
Step	Temperature	Time																											
1	100 to 120℃	1 min.																											
2	170 to 200℃	1 min.																											
14	稳态湿热 Humidity (under Steady State)	<table border="1"> <tr> <td>外观 Appearance</td> <td colspan="2">无显着异常 No marked defect</td> </tr> <tr> <td rowspan="3">容量变化 Capacitance Change</td> <td>SL</td> <td>±5%</td> </tr> <tr> <td>Y5P</td> <td>±10%</td> </tr> <tr> <td>Y5U</td> <td>±20%</td> </tr> <tr> <td rowspan="2">介质损耗/Q 值 D.F./Q</td> <td>SL</td> <td>≤0.3%</td> </tr> <tr> <td>Y5P Y5U</td> <td>≤5.0%</td> </tr> <tr> <td>绝缘电阻 I.R.</td> <td colspan="2">≥3000MΩ</td> </tr> </table>	外观 Appearance	无显着异常 No marked defect		容量变化 Capacitance Change	SL	±5%	Y5P	±10%	Y5U	±20%	介质损耗/Q 值 D.F./Q	SL	≤0.3%	Y5P Y5U	≤5.0%	绝缘电阻 I.R.	≥3000MΩ		<p>进行此试验前应首先进行如下试验 项目 11:弯 项目 12:焊接强度(施加 5N 测试力)，</p> <p>预处理：产品在 150 +0/-10℃下放置 60±5 分钟，然后在室温下放置 24±2h (B/E 材质适用)。在温度 40±2℃，湿度 90-95%RH 下置 500+24/-0 小时。</p> <p>Before this test, the test shown in the following is performed.</p> <ul style="list-style-type: none"> Item 11 Deflection Item 12 Adhesive Strength of Termination (applied force is 5N) <p>Set the capacitor for 500-0/+24 hrs. at 40±2℃ in 90 to 95% relative humidity.</p>								
外观 Appearance	无显着异常 No marked defect																												
容量变化 Capacitance Change	SL	±5%																											
	Y5P	±10%																											
	Y5U	±20%																											
介质损耗/Q 值 D.F./Q	SL	≤0.3%																											
	Y5P Y5U	≤5.0%																											
绝缘电阻 I.R.	≥3000MΩ																												

	惠州精勤电子元件有限公司 Huizhou Jingqin Electronic Components Co.LTD	FILE NO.	QC-T4-09
	贴片安规 Y 电容 (SMD-Y-CAP)	Ver:	1.0
		Page	16/21

		耐电压 Dielectric Strength	参考项目 7. Per Item 7.	Pretreatment: Perform a heat treatment at 150 +0/-10°C for 60±5 min. and then let sit for 24±2 hrs. at room condition (for Y5P、Y5U char) Post-treatment: The capacitor should be stored for 1 to 2 hours at room condition.	
15	湿热负荷 Humidity Loading	外观 Appearance	无显着异常 No marked defect	进行此试验前应首先进行如下试验: 项目 11:弯曲 项目 12:焊接强度(施加 5N 测试力) 预处理: 产品在 150 +0/-10°C 下放置 60±5 分钟, 然后在室温下放置 24±2h (B/E 材质适用)。在温度 40±2°C, 湿度 90-95%RH 下施加额定电压 500+24/-0 小时。 后处理:电容器应在室温环境下放置 24±2h Before this test, the test shown in the following is performed: Item 11 Deflection/Item 12 Adhesive Strength of Termination (applied force is 5N) Pretreatment: Perform a heat treatment at 150 +0/-10°C for 60±5 min. and then let sit for 24±2 hrs. at room condition (for Y5P、Y5U char) Apply the rated voltage for 500 -0/+24hrs. at 40±2°C in 90% to 95% relative humidity Post-treatment: Capacitor should be stored for 24± 2 hours at room condition.	
		容量变化 Capacitance Change	SL		±5%
			B		±10%
			E		±20%
		介质损耗/Q 值 D.F./Q	SL		≤0.3%
B/E	≤5.0%				
绝缘电阻 I.R.	≥3000MΩ				
		耐电压 Dielectric Strength	参考项目 7. Per Item 7.		
16	寿命试验 Life	外观 Appearance	无显着异常 No marked defect	进行此试验前应首先进行如下试验: 项目 11:弯曲 项目 12:焊接强度(施加 5N 测试力) 预处理: 产品在 150 +0/-10°C 下放置 60±5 分钟, 然后在室温下放置 24±2h (B/E 材质适用)。脉冲电压: 应对每个电容器实施 5KV(X1Y2)/8KV(X1Y1) 脉冲电压测试三次后, 完成后进行寿命测试 寿命测试: 在 125±2°C 及相对湿度低于 50%的条件下施加 170%额定电压 1000h, 每小时将电压增大至 AC1000V(r.m.s.), 保持时间 0.1 秒。 后处理:电容器应在室温环境下放置 24±2h Before this test, the test shown in the following is performed. Item 11 Deflection Item 12 Adhesive Strength of Termination (applied force is 5N)	
		容量变化 Capacitance Change	Within±20%		
		绝缘电阻 I.R.	≥3000MΩ		

	惠州精勤电子元件有限公司 Huizhou Jingqin Electronic Components Co.LTD	FILE NO.	QC-T4-09
	贴片安规 Y 电容 (SMD-Y-CAP)	Ver:	1.0
		Page	17/21

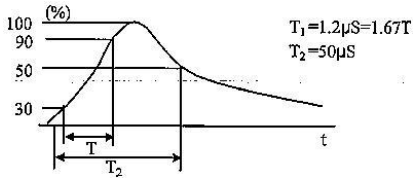
		耐电压 Dielectric Strength	参考项目 7. Per Item 7.	<p>Pretreatment: Perform a heat treatment at 150 +0/-10°C for 60±5 min. and then let sit for 24±2 hrs. at room condition (for Y5P、Y5U char)</p> <p>Impulse voltage Each individual capacitor should be subjected to a 5KV (X1Y2) / 8KV (X1Y1) impulse for three times. Then the capacitors are applied to life test. Apply a voltage of 170% of rated voltage except that once each hour the voltage is increased to AC1000V (r.m.s.) for 0.1sec for 1000 hrs., at 125 +2 °C and relative humidity of 50% max. -0</p> <p>Post-treatment::Capacitors should be stored for 24±2 hrs at room condition.</p> 
17	被动可燃性试验 (Passive Flammability)	燃烧时间不超过 30 秒。 薄纸不燃烧。 The burning time shall not be exceeded the time 30sec. The tissue paper shall not ignite.		<p>测试的电容器应在燃烧效果最佳的位置。每个样品应一次性燃烧。</p> <p>燃烧时间: 30 秒 火焰尺寸: 12±1mm 喷烧器: 35mm 长 内径: 0.5±0.1mm 外径: 最大 0.9mm 气体 : 纯度 95%以上的丁烷</p> <p>The capacitor under test shall be held in the position,which best promotes burning. Each specimen shall only be exposed once to flame. Time of exposure to flame: 30sec. Length of flame : 12±1mm Gas burner : Length 35mm min. Inside Dia. : 0.5±0.1mm Outside Dia. : 0.9mm max. Gas : Butane gas Purity 95% min.</p>

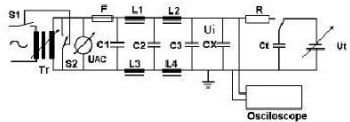
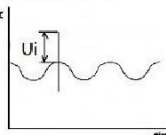
18	主动可燃性 (Active flammability) (Y2 适用)	缠绕在电容器上的纱布不燃烧。 The cheese-cloth should not be on fire.	<p>在电容本体外包装 1-2 层纱布，在下示回路每隔 5s 放电一次，放电 20 次。最后一次放电后，持续施加 2 分钟 UAC</p> <p>Ui=5KV</p> <p>The capacitors should be individually wrapped in at least one but more than two complete layers of cheese-cloth. The capacitor should be subjected to 20 discharges. The interval between successive discharges should be 5 s. The UAc should be maintained for 2min after the last discharge. Ui=5KV</p>  <p> C1,2 : 1μF±10%, C3 : 0.033μF±5% 10kV L1 to L4 : 1.5mH±20% 16A Rod core choke R : 100Ω±2%, Ct : 3μF±5% 10kV UAc : UR ±5% UR : Rated voltage Cx : Capacitor under test F : Fuse, Rated 10A Ut : Voltage applied to Ct </p> 
----	--	---	---

七.温度特性 (Temperature characteristic) :

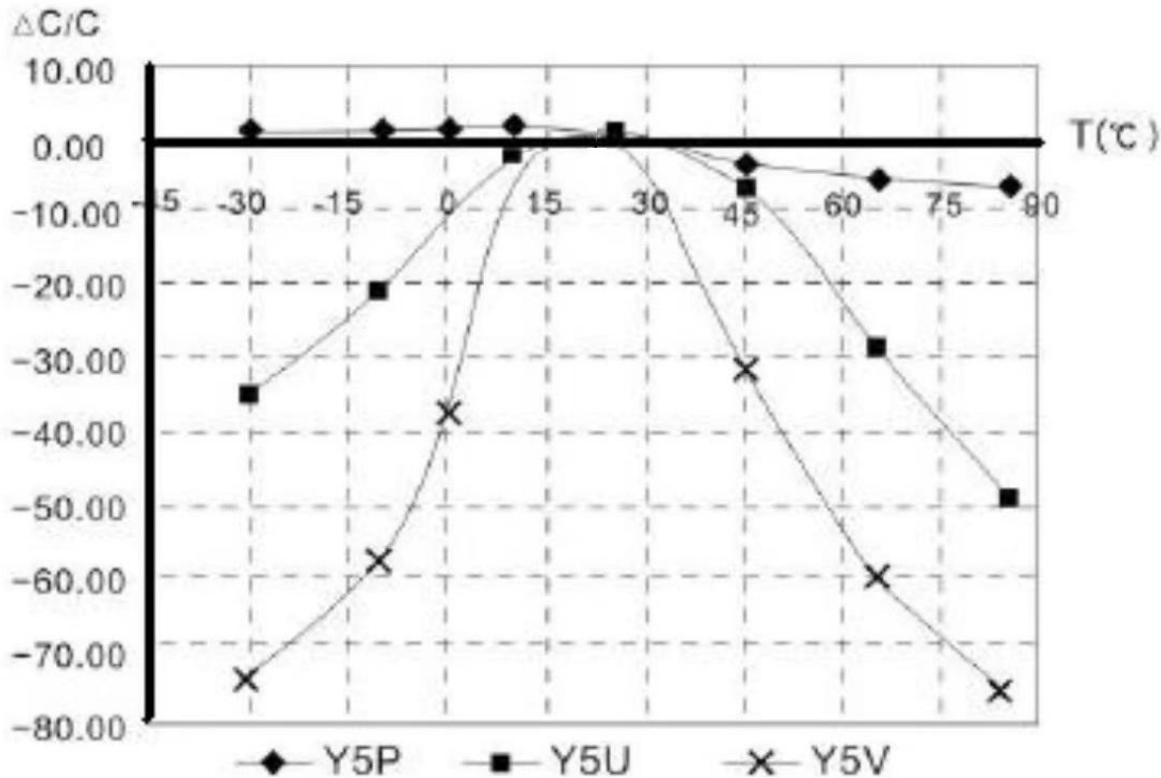

八.包装说明 (packing description) :

8.1 编带包装方式说明 Taping Packaging

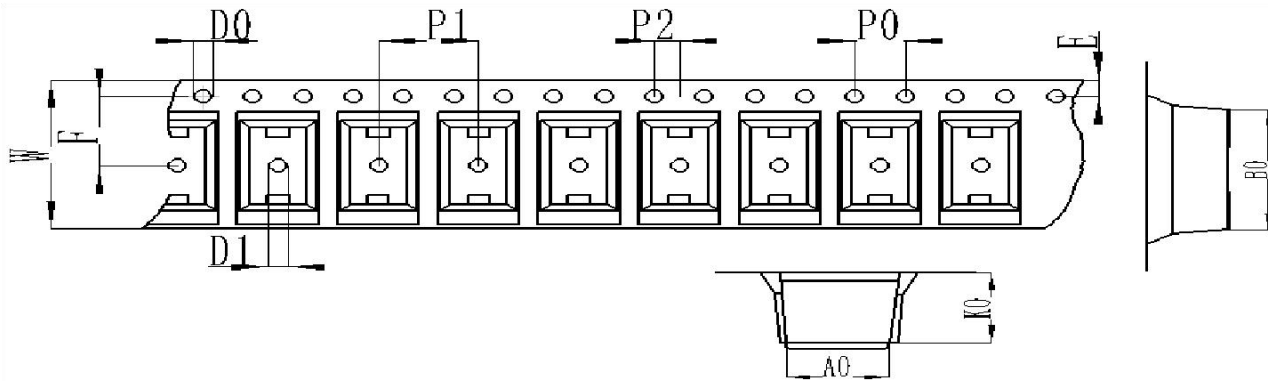

A0	B0	K0	P0	P1	P2
6.5±0.1	12.2±0.1	2.8±0.1	4.0±0.1	8.0±0.1	2.0±0.05
W	E	F	D0	D1	Pcs/Reel
24.0±0.2	1.75±0.1	7.5±0.1	1.5±0.1	1.5±0.1	4000

8.2 胶盘尺寸 15 inch plastic tray size

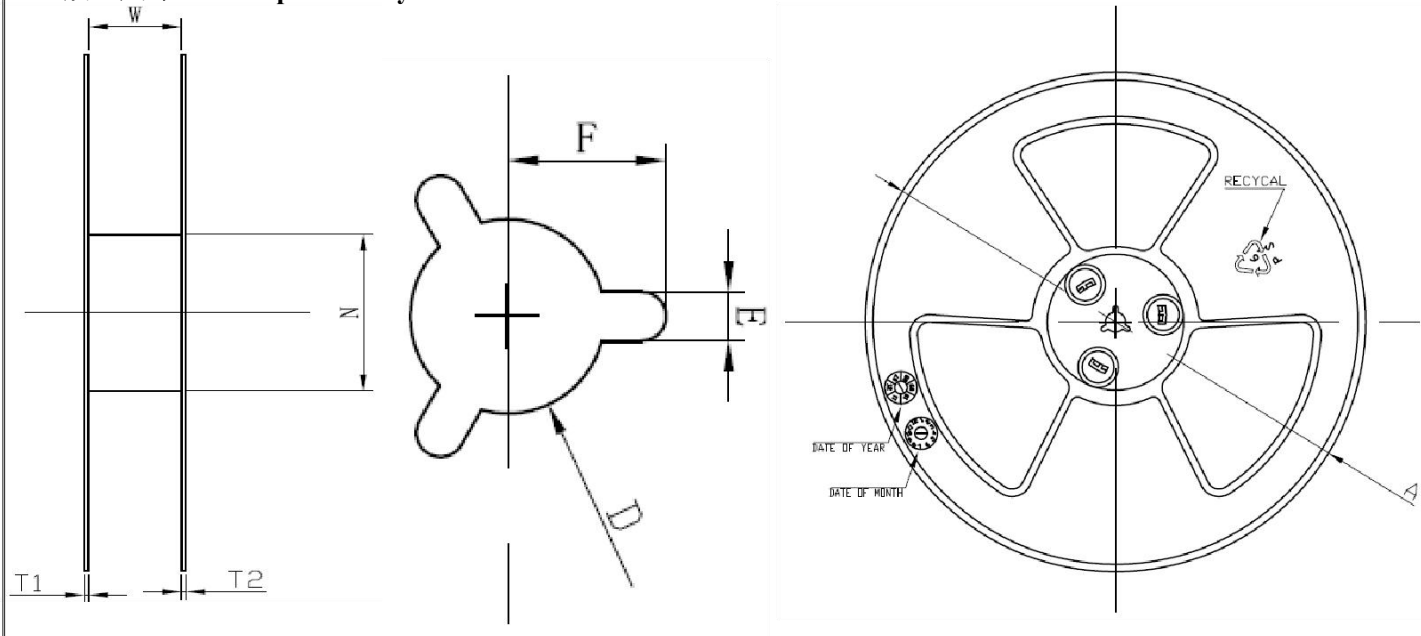

SPEC	W	N	T1	T2	A	D	E	F

8.3 包装纸箱 Carton Packing

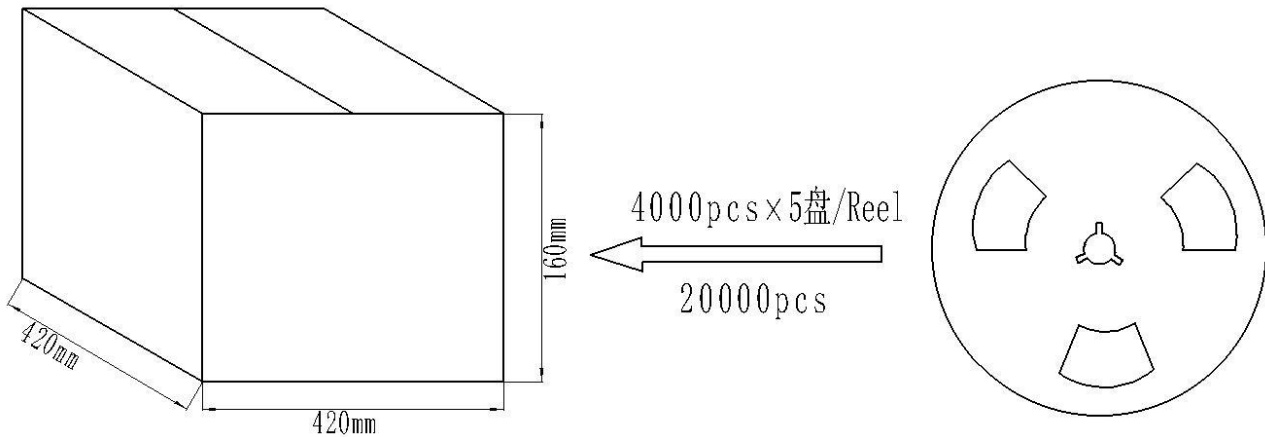

九. 焊接说明 Welding according to the instruction

2. 回流焊接曲线

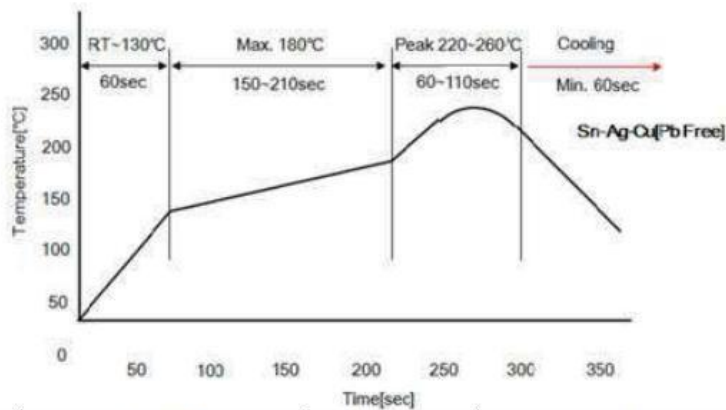

温区	温度范围 (°C)	时间 (sec)	备注
a	RT~130	60	焊锡: Sn-Ag-Cu 高温时间: < 10 sec
b	180 max	150~210	
c	220~260(260 max)	60~110	
d	220~RT	60 min	

当焊接温度低于锡的熔点时，贴片镀锡端子的可焊性将下降。使用之前请确认贴片镀锡电极的可焊性。焊接区出风口及内部空间最高温度不能超过 280℃，温度超过时，会造成产品发生失效。由于超温使用所造成的不良，我司不予承担责任。

■ 警告 (额定值)

1. 工作电压 e

在交流电路或纹波电路中使用直流额定电压电容器时，请务必将外加电压的 V_{p-p} 值或包含直流偏置电压的 V_{0-p} 值维持在额定电压范围内。

若向电路施压电压，开始或停止时可能会因谐振或切换产生暂时的异常电压。请务必使额定电压范围包含这些异常电压的电容器。

十. 注意事项 HANDLING PRECAUTIONS FOR CERAMIC CAPACITORS

10.1 使用电压 (Operating voltage)

使用电容器时，端子间施加的电压应该低于额定电压。直流电压上迭加交流电压时，峰值电压应该低于额定电压。用交流电压或脉冲电压时，峰电压也应该低于额定电压。另外，确认使用的电源设备是不是有可能印加异常电压（浪涌电压，静电，开关突峰电压），如果产生则异常电压也应该低于额定电压（如下图标）。交流一次侧回路时，用于防止杂波的电容器其交流耐压试验的实验条件不能超过规定的条件（电压、时间、波形）。

Use within the rated voltage of capacitor between terminals. For DC rated voltage application, you should control the peak voltage (V_{o-p}) under the rated voltage in case the AC voltage is superimposed on the DC voltage. Use within the rate voltage includes peak voltage (V_{p-p}) when AC voltage or impulse voltage applied in a circuit. Confirm irregular voltage (surge voltage, static electricity, switching noise, etc) occurs in the equipment used, and use within the rated voltage containing the irregular voltage. When the capacitor is used as a noise suppressor in the AC primary circuit, the voltage proof test should be within the specified conditions (voltage, time, wave form, etc).

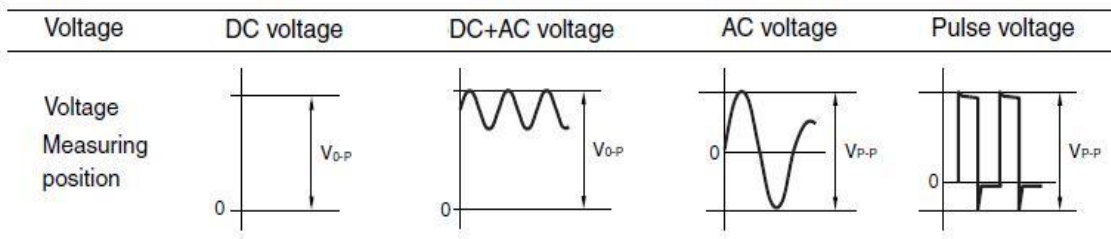

10.2 工作温度和自生热(Temperature & Self-exothermal)

使用时，电容器的表面温度，包括其自身发热，必须低于规格书规定的最高使用温度。在环境温度 25°C，无冷却风扇工作的状态下，自身发热（电容器的表面温度与环境温度的差值）必须在 20°C 以下。在连续印加交流电压或脉冲电压，电流较大的回路中，更要特别的注意，在连续印加高频电压，高频脉冲电压的回 中，虽然在额定电压以下，也有可能影响到信赖性，所以使用时要考虑减轻负荷及自身发热。

Be sure to use only those operating temperature described in our catalogue or specification. Keep the surface temperature under the maximum temperature, which includes the maximum self-heat temperature.

Self-exothermal temperature should be within 20°C on the condition of atmosphere temperature 25°C without the influence of wind such as the cooling fan. Be sure to use a capacitor in a circuit of current increase by AC voltage or pulse voltage applied.

When high frequency voltage or impulse voltage applied in a circuit, reliability should be influenced. Take into considerations the load reduction and self-exothermal temperature, even if voltage should be within the rated voltage.

10.3 耐电压的测试条件:

(1) 测试设备

- 1、交流耐压的测试设备应具有能够产生类似于 50/60Hz 正弦波的性能。
- 2、如果施加变形的正弦波或超过规定电压值的过载电压后，则可能会导致故障。

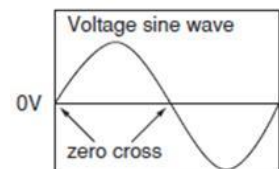

(2) 电压测试方法及要求:

耐压测试时，电容器的端子应与耐电压测试设备的输出端连接牢固；然后将电压从近零增加到测试电压。

如果测试电压不从近零逐渐提高而是直接施加在电容器上，则施加时应包含过零点*。测试结束时，测试电压应

降到近零；然后再将电容器引线或端子从耐电压测试设备的输出端取下。

	惠州精勤电子元件有限公司 Huizhou Jingqin Electronic Components Co.LTD	FILE NO.	QC-T4-09
		Ver:	1.0
	贴片安规 Y 电容 (SMD-Y·CAP)	Page	22/21

10.4. 失效安全性:

电容器损坏时，失效可能会导致短路。为了避免再短路时引起出点、冒烟、火灾等危险情况，请在电路中使用熔丝等原件来设置自动防故障功能。

△! 使用本产品时如忽略上述警告事项，则在严重情况下可能导致短路，并引起冒烟或局部离散

△! 警告(保管和使用条件)

电容器的绝缘涂层不具有完全的密封作用;因此，请勿将电容器存放在腐蚀性气体中，尤其是存在氯气、硫气、酸、碱、盐等的场所。同时应防潮。在对本产品进行清洗、覆膜或封膜前，请先在指定设备上测试经清洗、覆膜或封膜的产品性能，以确定上述过程不会影响产品质量。

这是 MSL3 产品。因此，为了避免吸收水分，电容器采用防潮包装。

在下述条件下储存产品，并在交付后 6 个月内使用产品。

温度:10to30°C 湿度:60%max.

如果超过 6 个月的储存期，或包装打开后有明显受潮迹象则，应在焊接前进行烘烤。60°C*168hr.

当打开包装的产品曝露时间超过裸露寿命，或者其它情况导致产品周围的温度、湿度超过要求以后，回流焊前产品湿度超过要求以后进行烘烤的参考数据(烘烤后裸露寿命从零开始计时)

Level	Bake@40C ζ5%RH	
	Saturated@30C/85%RH	At limit of Floor life+72hr@30C/60RH
3	79days	67days

△! 使用本产品时如忽略上述警告事项，则在严重情况下可能导致短路，并引起冒烟或局部离散。

△! 警告(焊接、安装与使用)

1、振荡与冲击

使用时请勿使电容器或引线受到过度冲击或振荡，过度冲击或振荡会对安装在电路板上的引线造成疲劳破坏。

使用粘合剂、封膜树脂或其它涂层将电容器固定在电路板上。使用指定设备进行固定时，请确认固定措施对产品不会造成影响。

2、焊接

当将本产品焊接到 PCB/PWB 上时，不得超过电容器的耐焊热性规格。本产品如果过热，可能导致内部连接点锡焊料

惠州精勤电子元件有限公司。当使用 Jingqin 烙铁焊接 Electronic 电容器时，Components 应遵循以下条件。

烙铁头温度:最高 400C

烙铁功率: 最大 50W

焊接时间: 最多 3.5 秒

	惠州精勤电子元件有限公司 Huizhou Jingqin Electronic Components Co.LTD	FILE NO.	QC-T4-09
	贴片安规 Y 电容 (SMD-Y-CAP)	Ver:	1.0
		Page	23/21

3、粘合、树脂封膜和树脂涂敷

在对本产品进行粘合、封膜或施加涂层前，请先在指定设备上测试经粘合、封膜或涂敷的产品的性能，以确定上述过程不会影响电容器的质量。

当含有有机溶剂(乙酸乙酯、甲基乙基酞、甲苯等)的粘合剂和封膜树脂的使用量、干燥/硬化条件不适当时，有机溶剂可能损坏电容器的外涂层树脂，最坏条件下可能导致短路。

粘合剂、封膜树脂和有机溶剂的厚度变化也会造成电容器表面树脂涂层和陶瓷组件在温度周期变化过程中产生裂纹。

4、粘合、树脂封膜和树脂涂敷后的处理

焊接后，当外涂层很热(超过 100C)时，外涂层会变得很软、易碎。

因此，请注意不要对涂层施加机械冲击力。

 **!使用本产品时如忽略上述警告事项，则在严重情况下可能导致短路，并引起冒烟或局部离散。**

注意事项(焊接与安装)

清洗(超声波清洗)

进行超声清洗时，遵守下列条件:

洗涤槽容量: 每升输出 20W 或更少。洗涤时间: 最长 5 分钟。

不得直接振荡 PCB/PWB。超声波清洗过度可能导致引线疲劳性破坏。

注意事项(额定值)Notice(Rating)

1. 电容器的电容量变化

(1) SL、DL 特性

电容量由于周围的温度或施加的电压可能会改变一点点。

如果应用于严格的时间常数电路，与我公司联系。

(2) Y5P、Y5U 特性

电容器具有老化特性;因此电容器若长时间存放使用，其电容量会逐渐降低。而且，静电容量还可能会因周围温度或外加电压而发生巨大变化。所以不适合用于时间常数电路。

若需详情，请与我公司联系。

2. 使用设备进行性能检查

使用电容器之前，请先检查设备的性能和特性没有问题。

一般而言，2 类陶瓷电容器(Y5P、Y5U 特性)的电容量具有电压相关特性和温度相关特性。所以，其电容值可能会随设备的工作条件而发生变化。因此，一定要确认仪器接收性能对电容器的静电容值变化的影响，如漏电流和静噪特性。

此外，必要时还要检查电容器在设备中的防电涌性能，因为通过电路的感应，浪涌电压可能会超过规定值。