

产品承认书

客户名称: 立创商城

产品名称: SMD-Y1 塑封交流陶瓷电容器

规格描述: SMD-1Y1 SL-680J/500VAC 2822

产品编码: JA1Y1X1SL680J500VAC2

客户料号: _____

制作日期: 2025-05-24

供应商签署栏			
制作	审核	批准	
邓光彦	张云云	孙洪淇	

客户确认栏			
承认	审核	批准	结论:
			<input type="checkbox"/> 合格 <input type="checkbox"/> 不合格 <input type="checkbox"/> 其它:

烦请确认后回传，以方便交货确认；未回签表示默认合格，订货合同按此样品执行交货。

供应商信息:

地址: 东莞市厚街镇三屯村上屯上涌路 28 号 C 栋四楼 A 区

电话: +86 769 85885761

传真: +86 769 85885771

邮箱: qe@jk-et.com

网址: <http://www.jk-et.com>



东莞市健坤(健而威)电子科技有限公司

DONG GUAN CITY JIANKUN (JIANERWEI) ELECTRONICS TECHNOLOGY CO., LTD

SMD-Y1 塑封交流陶瓷电容器

一、产品特点

1. 先进的封装工艺, 封装材料满足 UL94-V0

Advanced packaging technology, packaging materials meet UL94-V0

2. 结构紧凑, 体积小, 节省空间 Compact structure, small size, space saving
3. 优越的耐高温高湿性能 Superior high temperature and high humidity performance
4. 强大的耐压能力 Strong ability to suppress high surge and high current
5. SMD 料盘包装, 适用于无铅回流焊自动贴装

SMD tray packaging, suitable for lead-free reflow soldering automatic placement

6. 符合 RoHS(高铅 RoHS 豁免), REACH, Halogen Free 无卤 Conform to RoHS, REACH, H.F

7. 安规认证:

认证机构	CQC	UL	ENEC
证书号	CQC22001360386	E340699	ENEC-04203



二、应用范围

1. LED 电路保护 LED circuit protection
2. 工业设备 Industrial equipment
3. 通讯设备 Communication equipment
4. 汽车电子 Automotive Electronics

三、产品标准

1. UL60384-14
2. EN60384-14
3. GB/T6346.14

四、温度范围

参数名称	参数值	单位
工作温度	-40 ~ +125	°C
储存温度	+10 ~ +40	°C



五、产品编码

①	②	③	④	⑤	⑥	⑦	⑧
JA	1	Y1X1	SL	680	J	500VAC	2
系列代码	结构	电容器类别	材质	电容量	电容量误差	额定电压	封装尺寸
塑封 Y1 电容	1 只芯片	Y1X1	SL:SL	68pF	±5%	500VAC 250VAC	2822 (7*5.6* 2.4)

六、规格明细

NO.	产品编码	规格描述	材质	电容量 (pF)
1	JA1Y1X1SL100J500VAC2	SMD-1Y1 SL-100J/500VAC 2822	SL	10
2	JA1Y1X1SL220J500VAC2	SMD-1Y1 SL-220J/500VAC 2822	SL	22
3	JA1Y1X1SL470J500VAC2	SMD-1Y1 SL-470J/500VAC 2822	SL	47
4	JA1Y1X1SL560J500VAC2	SMD-1Y1 SL-560J/500VAC 2822	SL	56
5	JA1Y1X1SL680J500VAC2	SMD-1Y1 SL-680J/500VAC 2822	SL	68
6	JA1Y1X1B101K500VAC2	SMD-1Y1 Y5P-101K/500VAC 2822	Y5P	100
7	JA1Y1X1B111K500VAC2	SMD-1Y1 Y5P-111K/500VAC 2822	Y5P	110
8	JA1Y1X1B121K500VAC2	SMD-1Y1 Y5P-121K/500VAC 2822	Y5P	120
9	JA1Y1X1B151K500VAC2	SMD-1Y1 Y5P-151K/500VAC 2822	Y5P	150
10	JA1Y1X1B201K500VAC2	SMD-1Y1 Y5P-201K/500VAC 2822	Y5P	200
11	JA1Y1X1B221K500VAC2	SMD-1Y1 Y5P-221K/500VAC 2822	Y5P	220
12	JA1Y1X1B271K500VAC2	SMD-1Y1 Y5P-271K/500VAC 2822	Y5P	270
13	JA1Y1X1B331K500VAC2	SMD-1Y1 Y5P-331K/500VAC 2822	Y5P	330
14	JA1Y1X1B391K500VAC2	SMD-1Y1 Y5P-391K/500VAC 2822	Y5P	390
15	JA1Y1X1B471K500VAC2	SMD-1Y1 Y5P-471K/500VAC 2822	Y5P	470
16	JA1Y1X1E561M500VAC2	SMD-1Y1 Y5U-561M/500VAC 2822	Y5U	560
17	JA1Y1X1E681M500VAC2	SMD-1Y1 Y5U-681M/500VAC 2822	Y5U	680
18	JA1Y1X1E821M500VAC2	SMD-1Y1 Y5U-821M/500VAC 2822	Y5U	820
19	JA1Y1X1E102M500VAC2	SMD-1Y1 Y5U-102M/500VAC 2822	Y5U	1000
20	JA1Y1X1E152M500VAC2	SMD-1Y1 Y5U-152M/500VAC 2822	Y5U	1500
21	JA1Y1X1F102M500VAC2	SMD-1Y1 Y5V-102M/500VAC 2822	Y5V	1000
22	JA1Y1X1F152M500VAC2	SMD-1Y1 Y5V-152M/500VAC 2822	Y5V	1500
23	JA1Y1X1F222M500VAC2	SMD-1Y1 Y5V-222M/500VAC 2822	Y5V	2200

七、外观尺寸 (单位 mm)

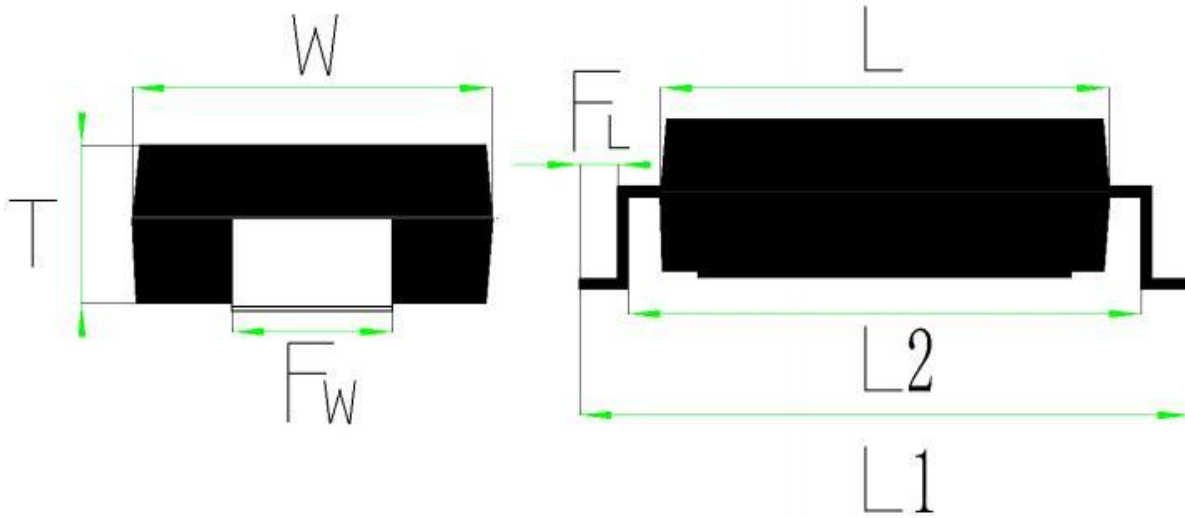

代码	L	W	T	L1	L2	FL	FW
尺寸	7.0±0.3	5.6±0.3	2.4±0.1	9.5±0.2	8.5±0.2	0.5±0.3	2.5±0.3

八、焊盘尺寸 (单位 mm)

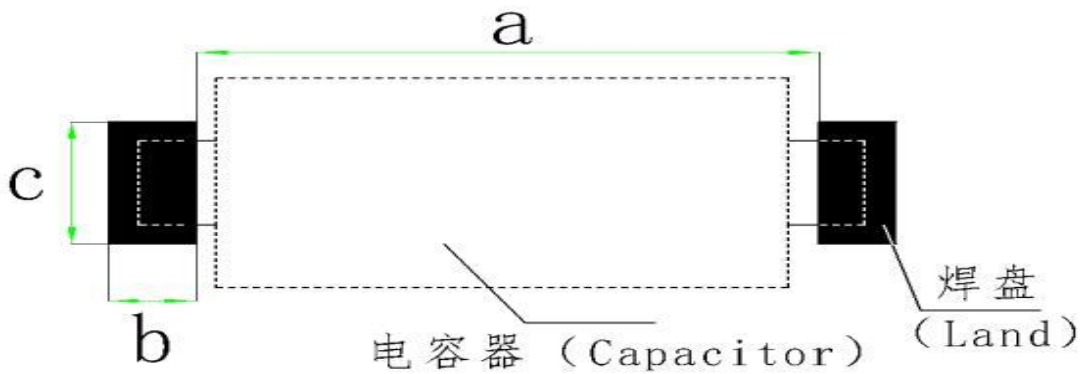

代码	a	b	c
尺寸	8	1	3.5

九、产品结构图

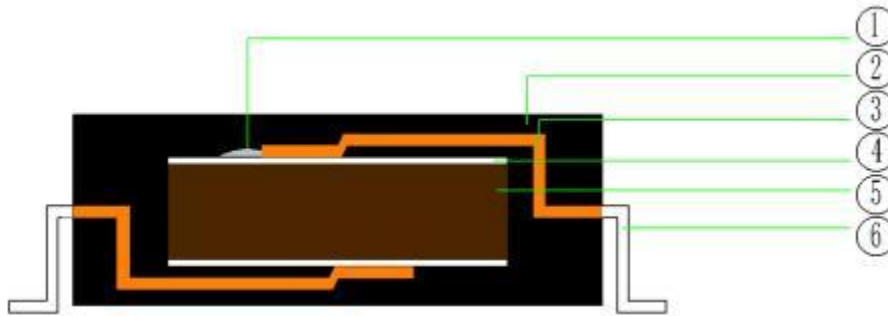

序号	名称	材料
①	焊料	Sn-Pb-Ag 高铅 RoHS 豁免
②	包封层	环氧树脂 (UL94V-0 认定品)
③	内部引脚	电子框架合金
④	电极	银/铜电极
⑤	介质	陶瓷介质
⑥	SMD 贴片引脚	合金镀锡

十、产品印字

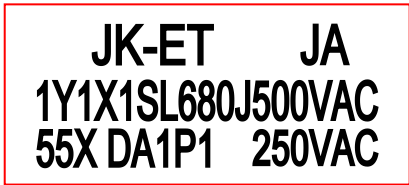

JK-ET	商标	680	电容量代码
JA	系列代码	J	电容量误差代码
1	结构 (见第 9 项说明)	500VAC	额定电压
Y1X1	电容器类别	250VAC	
SL	材质代码	55X DA1P1	追踪识别码

十一、性能与试验 Performance and test

NO	项目 ITEMS	判定标准 PERFORMANCE	试验方法 TESTING METHOD													
1	外观、尺寸检查 Appearance and dimension	表面清洁, 无异物, 无可见损伤, 尺寸符合规定要求 Clean surface, no visible damage, Dimension according to ordain requirement	目视检查外观 Visual check of Appearance 用卡尺测量尺寸 Measure the size with vernier caliper.													
2	标志 marking	标志清晰正确 The marking shall be easily legible	用目测法观测 Visual check													
3	耐电压 Withstand Voltage	端子间 Between lead wire	无永久性击穿或飞弧 No permanent break-down or flashover during the test period													
		本体绝缘 Body insulation	无永久性击穿或飞弧 No permanent break-down or flashover during the test period													
4	电容量 Capacitance	在规定的允许偏差范围内 within the specified tolerance.	环境温度(Temperature): 25±2°C: 测量频率(Test Frequency): 1KHz±20% (SL: 1MHz±20%) 测量电压(Test Voltage): 1.0Vrms													
5	损耗角正切 Tan δ Dissipation factor	Y5P Y5U Y5V SL		tgδ≤0.025 tgδ≤0.001												
6	绝缘电阻 Insulation Resistance	≥6000MΩ	充电电压 (Test Voltage) : 500V DC 充电时间 (Test Time) : 60±5s													
7	温度特性 Temperature Characteristics	符合类别温度范围内的电容量变化率Δ:		依表中各温度段进行容量测试, 并计算出变化率 The capacitance measurement shall be made at each step specified in table <table border="1"> <thead> <tr> <th>STEP</th> <th>TEMPERATURE</th> </tr> </thead> <tbody> <tr> <td>1</td> <td>+20±2°C</td> </tr> <tr> <td>2</td> <td>-25±2°C</td> </tr> <tr> <td>3</td> <td>+20±2°C</td> </tr> <tr> <td>4</td> <td>+85±2°C</td> </tr> <tr> <td>5</td> <td>+20±2°C</td> </tr> </tbody> </table> Δ=(Cx-C0)/C0*100% Cx : 第 2 或 4 测点测试的电容量 C0 : 第 3 测点测试的电容量 SL: Δ = [(C2-C1) * 10 ⁶]/[C1(T2-T1)] C1 : Capacitance at standard temperature (20°C). C2 : Capacitance at each temperature. T1 : Test temperature (Min. Temp. and Max. Temp.) T2 : Reference temperature	STEP	TEMPERATURE	1	+20±2°C	2	-25±2°C	3	+20±2°C	4	+85±2°C	5	+20±2°C
		STEP	TEMPERATURE													
		1	+20±2°C													
		2	-25±2°C													
		3	+20±2°C													
4	+85±2°C															
5	+20±2°C															
Y5P	±10%															
Y5U	-56% ~ +22%															
Y5V	-82% ~ +30%															
SL	-1000~+350PPM/°C (+20~85°C)															

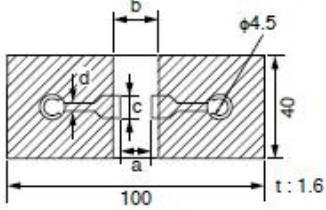
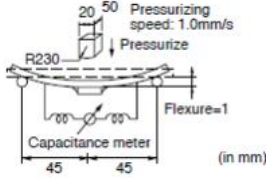
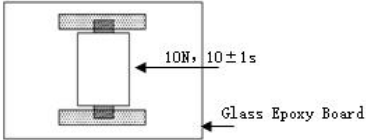
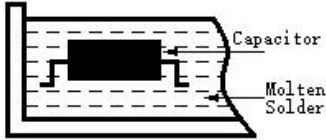
<p>8</p>	<p>弯曲 Deflection</p>	<p>无可见损伤 No visible damage</p>  <table border="1" data-bbox="434 510 837 622"> <thead> <tr> <th colspan="4">Dimension()</th> </tr> <tr> <th>a</th> <th>b</th> <th>c</th> <th>d</th> </tr> </thead> <tbody> <tr> <td>9.6</td> <td>11.7</td> <td>2.7</td> <td>1.0</td> </tr> </tbody> </table>	Dimension()				a	b	c	d	9.6	11.7	2.7	1.0	<p>将电容器焊接在图一所示的测试夹具上，施如图一所示的测试力；电容器应采用回流焊法焊接，并进行护理，以保证电容器不会受热冲击等破坏</p> <p>Solder the capacitor to the test jig(glass epoxy board)shown in Fig.1; Then apply a force in the direction shown in Fig.1. The soldering should be done using reflow method and should be conducted with care so that the soldering is uniform a free of defects such as heat shock.</p> <p>Fig.1</p> 				
Dimension()																			
a	b	c	d																
9.6	11.7	2.7	1.0																
<p>9</p>	<p>可焊性 Solderability of leads</p>	<p>焊料分布均匀，覆盖周边 75%区域 (75% of the terminations are to be soldered evenly and continuously.)</p>	<p>电容器引线进入 25% 的酒精松香焊剂后，浸入温度为 245±5°C(Sn-3.0Ag-0.50u)的熔锡内 2±0.5s，浸入速度 25±2.5mm/s。Immerse the capacitor in a solution of ethanol (JIS-K-8101) and rosin (JIS-K-5902) (25% rosin in weight proportion). Immerse in solder solution for 2±0.5 sec ,Immersing speed: 25±2.5mm/s Temp. of solder: 245±5°C Lead Free Solder (Sn-3.0Ag-0.5Cu)</p>																
<p>10</p>	<p>焊接强度 Adhesive Strength of Termination</p>	<p>引脚无偏移或发生其他不良 (No removal of the terminations or other defect should occur.)</p>	<p>将电容器焊接在图 2 所示的测试夹具上，施加箭头所示方向的 10N 推力；电容器应采用回流焊法焊接，并进行护理，以保证电容器不会受热冲击等破坏。</p> <p>Solder the capacitor to the test jig(glass epoxy board)shown in Fig.2; Then apply 10N force in the direction of the arrow. The soldering should be done using reflow method and should be conducted with care so that the soldering is uniform and free of defects such as heat shock.</p> 																
<p>11</p>	<p>耐焊接热 Resistance to Soldering Heat</p>	<table border="1" data-bbox="427 1505 836 2069"> <tr> <td>外观 Appearance</td> <td colspan="2">无可见损伤 No visible damage</td> </tr> <tr> <td rowspan="3">电容量变化 Capacitance Change</td> <td>SL</td> <td>±5%</td> </tr> <tr> <td>B</td> <td>±10%</td> </tr> <tr> <td>E F</td> <td>±20%</td> </tr> <tr> <td>绝缘电阻 I.R.</td> <td colspan="2">1000MΩ min</td> </tr> <tr> <td>耐电压 Dielectric Strength</td> <td colspan="2">参考项目 3 Per Item 3.</td> </tr> </table>	外观 Appearance	无可见损伤 No visible damage		电容量变化 Capacitance Change	SL	±5%	B	±10%	E F	±20%	绝缘电阻 I.R.	1000MΩ min		耐电压 Dielectric Strength	参考项目 3 Per Item 3.		<p>将电容器浸入 260±5°C熔锡中 10±1 秒，浸入速度 25±2.5mm/s，在室温下放置 24±2h 后测试。</p> <p>Preheat the capacitor as in table. Immerse the capacitor in solder solution at 260±5°Cfor 10±1 sec. Let sit at room condition for 24±2 hrs., then measured.</p> <p>Immersing speed: 25±2.5mm/s</p> <p>Pretreatment: Perform a heat treatment at 150 +0/-10°C for 60±5 min. and then let sit for 24±2 hrs. at room condition.</p> 
外观 Appearance	无可见损伤 No visible damage																		
电容量变化 Capacitance Change	SL	±5%																	
	B	±10%																	
	E F	±20%																	
绝缘电阻 I.R.	1000MΩ min																		
耐电压 Dielectric Strength	参考项目 3 Per Item 3.																		

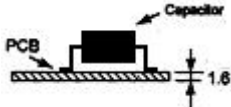
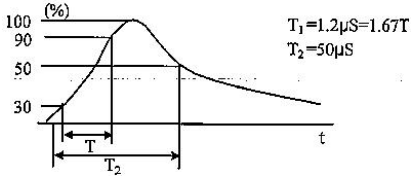
12	耐振性 Vibration Resistance	外观 Appearance	无可见损伤 No visible damage		<p>将电容器焊接在测试夹具上，并经如下振动频率 10Hz-55Hz-10Hz 全振幅 1.5mm，1 分钟内完全重复振动。此试验如无特别规定应在彼此互相成垂直的方向各操作 2 小时(合计 6 小时)后检查电容器有无机械损伤。</p> <p>Solder the capacitor to the test jig (glass epoxy board).The capacitor should be subjected to a simple harmonic motion having a total amplitude of 1.5mm, the frequency being varied uniformly between the approximate limits of 10 to 55Hz.The frequency range, from 10 to 55Hz and return to 10Hz, should be traversed in approximately 1min.This motion should be applied for a period of 2hrs.in each of 3 mutually perpendicular directions (total of 6hrs.).</p> 	
		电容量 Capacitance	在规定的允许偏差范围内 within the specified tolerance.			
		损耗角正切 $\tan \delta$ Dissipation factor	在规定的允许偏差范围内 within the specified tolerance.			
13	稳态湿热 Humidity (Steady State)	外观 Appearance	无可见损伤 No visible damage		<p>试验温度: 40±2°C 相对湿度: 93±3%RH 持续时间: 21 天 (504+24/-0 小时) 施加电压: 500VAC(U_R)一半电容施加电压, 一半不施加电压 试验后电容恢复: 24 小时, 25±3°C Test temperature: 40±2°C Humidity: 93±3%RH duration: 504+24/-0 hours Voltage: 500VAC(U_R)for one half of the samples. After test the capacitors shall be recovered for 24hours at 25±3°C</p>	
		电容量变化 Capacitance Change	SL	±5%		
			B	±10%		
			E F	±20%		
		损耗角正切 $\tan \delta$ Dissipation factor	SL	≤0.3%		
			B E F	≤5.0%		
绝缘电阻 I.R.	≥3000MΩ					
耐电压 Dielectric Strength	参考项目 3. Per Item3.					
14	脉冲电压 Impulse voltage	无永久性击穿或飞弧。 No permanent breakdown or flashover during the test period.		<p>脉冲电压: 8.0KV 脉冲间隔时间: > 10 秒 脉冲次数: 24 次 (脉冲极性相同) Peak impulse voltage:8.0KV Impulses distance :> 10seconds Impulses times:24</p> 		
		<p>监视器出现有三次连续脉冲波形表示电容器未发生自愈性击穿, 可停止施加脉冲, 判为合格。 If any three successive impulses are shown by the oscilloscope monitor to have had a waveform indicating that no self-healing breakdowns or flashovers have taken place in the capacitor, then no further impulses shall be applied and the capacitor shall be counted as conforming.</p>				
		<p>施加 24 次脉冲后电容器有三次或更多次的波形表示未发生自愈性击穿, 判为合格。 If all 24 impulses have been applied to the capacitor and 3 or more of them are of a waveform indicating that no self-healing breakdowns or flashovers have occurred, then the capacitor shall be counted as conforming.</p>				
		规定波形的脉冲少于三次, 则判电容器失效不合格。 If less than three impulses are of the required waveform, then the capacitor shall be counted as a nonconforming item.				

15	耐久性 Endurance	外观 Appearance	无可见损伤 No visible damage	试验温度: 125±3°C 持续时间: 1000+24/0 小时 施加电压: 850VAC(1.7U _R) 试验后电容恢复: 24 小时, 25±3°C Test temperature: 125±3°C Duration: 1000+24/-0hours test voltage: 850VAC(1.7U _R), except that once every hour the voltage shall be increased to 1000v r.m.s. for 0.1s. Each of these voltage shall be applied To each capacitor individually through a resistor of 47Ω±5%. After test the capacitors shall be recovered for 24±2hours at 25±3°C
		电容量变化 Capacitance Change	Within±20%	
		绝缘电阻 I.R.	≥3000MΩ	
		耐电压 Dielectric Strength	参考项目 3. Per Item 3.	
16	阻燃性 Passive Flammability	燃烧时间不超过 30 秒。 薄纸不燃烧。 The burning time shall not be exceeded the time 30sec. The tissue paper shall not ignite.	测试的电容器应在燃烧效果最佳的位置。每个样品应一次性燃烧。 燃烧时间: 30 秒 火焰尺寸: 12±1mm 喷烧器长度: 35mm 内径: 0.5±0.1mm 外径: 最大 0.9mm 气体 : 纯度 95%以上的丁烷 The capacitor under test shall be held in the position, which best promotes burning. Each specimen shall only be exposed once to flame. Time of exposure to flame: 30sec. Length of flame : 12±1mm Gas burner : Length 35mm min. Inside Dia. : 0.5±0.1mm Outside Dia. : 0.9mm max. Gas : Butane gas Purity 95% min.	

十二、包装说明(packing description):

A 卷带包装 Taping Packaging

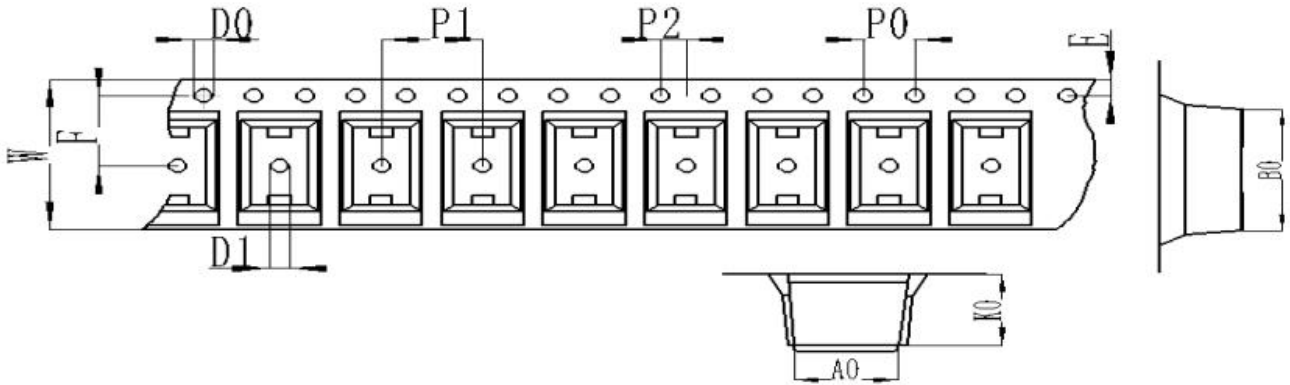

A0	B0	K0	P0	P1	P2
6.5±0.1	10.5±0.1	2.8±0.1	4.0±0.1	8.0±0.1	2.0±0.05
W	E	F	D0	D1	Pcs/Reel
16.0±0.1	1.75±0.1	7.5±0.1	1.5±0.1	1.5±0.1	4000

B 胶盘尺寸 15 inch plastic tray size

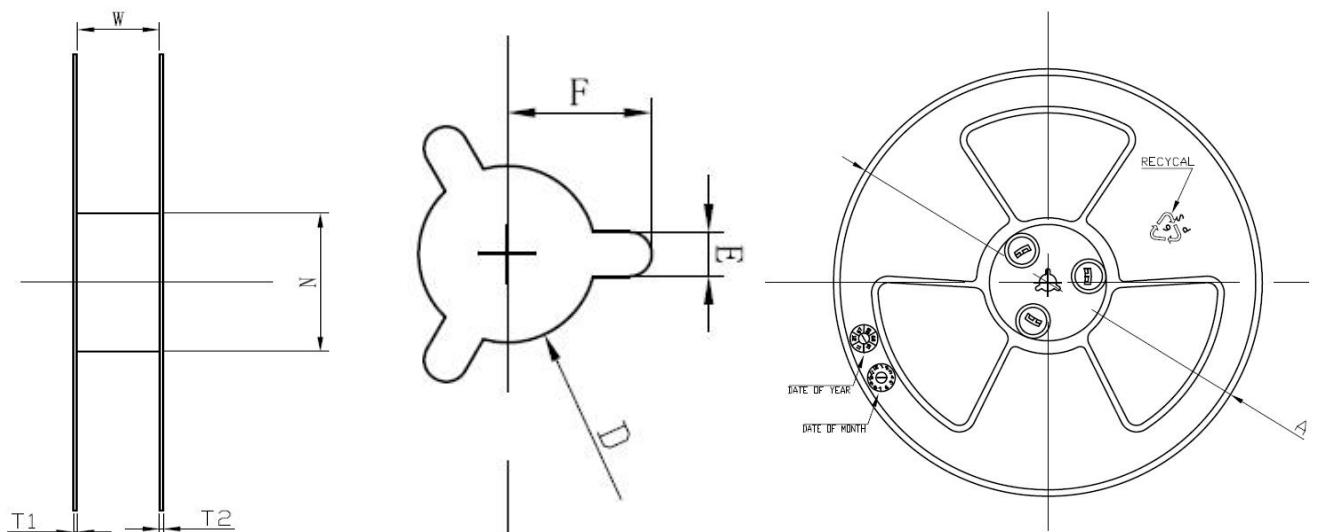

代码	W	N	T1	T2	A	D	E	F
尺寸	16.4±0.3	Φ100±3.0	2.2±0.3	2.2±0.3	Φ380±3.0	13.3±0.3	2.3±0.5	10.75±0.5

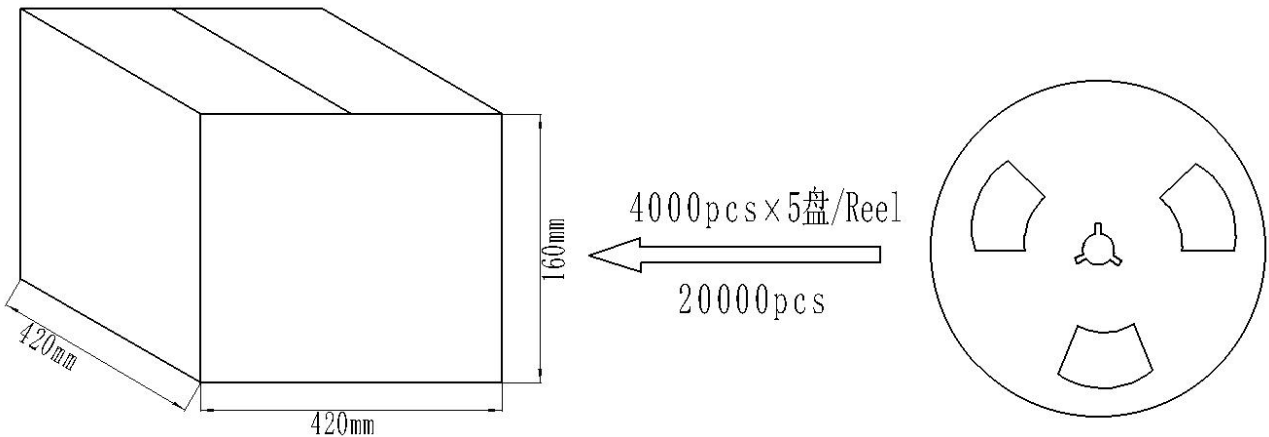

D 标签

JK-ET CERAMIC CAPACITOR			
TYPE			
CAP		T. C	
W. V		TOL	
L*W*T		QTY	PCS
Lot No			
P/N			

十三、回流焊接说明 Welding according to the instruction

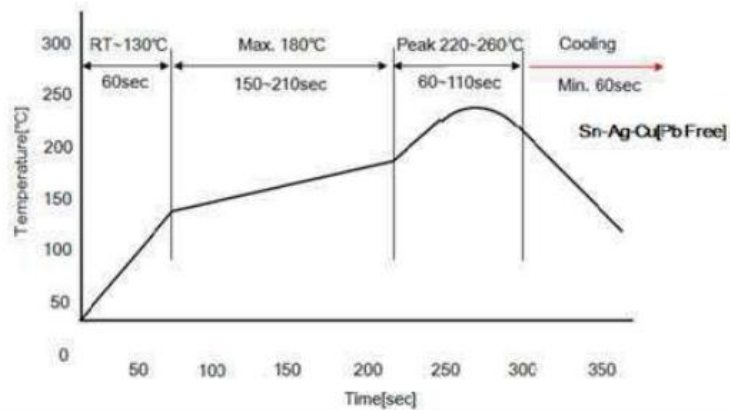

温区	温度范围 (°C)	时间 (sec)	备注
a	RT~130	60	焊锡: Sn-Ag-Cu 高温时间: < 10 sec
b	180 max	150~210	
c	220~260(260 max)	60~110	
d	220~RT	60 min	

当焊接温度低于锡的熔点时，贴片镀锡端子的可焊性将下降。使用之前请确认贴片镀锡电极的可焊性
焊接区出风口及内部空间最高温度不能超过 280°C，温度超过时，会造成产品发生失效。由于超温使用所造成的不良，我司不予承担责任。