



东莞市科雅电子科技有限公司

规格承认书

SPECIFICATIONS FOR APPROVAL

TEL:0769-83919069 FAX:0769-83500269

客户名称 CUSTOMER	立创商城
规格类别 DESCRIPTION	MKP-X2 抑制电源电磁干扰用固定电容器
科雅料号 KEYA P/N	PX103K2C1003 X2 103K310VAC P10 13*11*5 双 85 高温 高湿 电网专用
客户料号 CUSTOMER P/N	
承认编号 APPROVAL NO	20240821004
发行日期 ISSUED DATE	2024. 8. 21

东莞市科雅电子科技有限公司
 广东省东莞市常平镇朗贝村常泰新村 4 街 128 号
 TEL: 0769-83919069 FAX: 0769-83500269
 Website : HTTP://www.dgkeya.cn
 www.dgkeya.com



客户承认栏 CUSTOMER APPROVAL

製作 PREPARED BY	審核 CHECKED BY	核準 APPROVAL BY

©This specification will be invalidated assuming that it is not accepted when it is not returned within sixth months from the date of issue.

此承认书若未在发行日期起二个月内签回，将视为无效。

东莞市科雅电子科技有限公司

SPECIFICATION	东莞市科雅电子科技有限公司
客户名称 CUSTOMER	立创商城
科雅型号 KYET TYPE	MKP-X2

1.产品尺寸图 **PRODUCT DIMENSIONS**

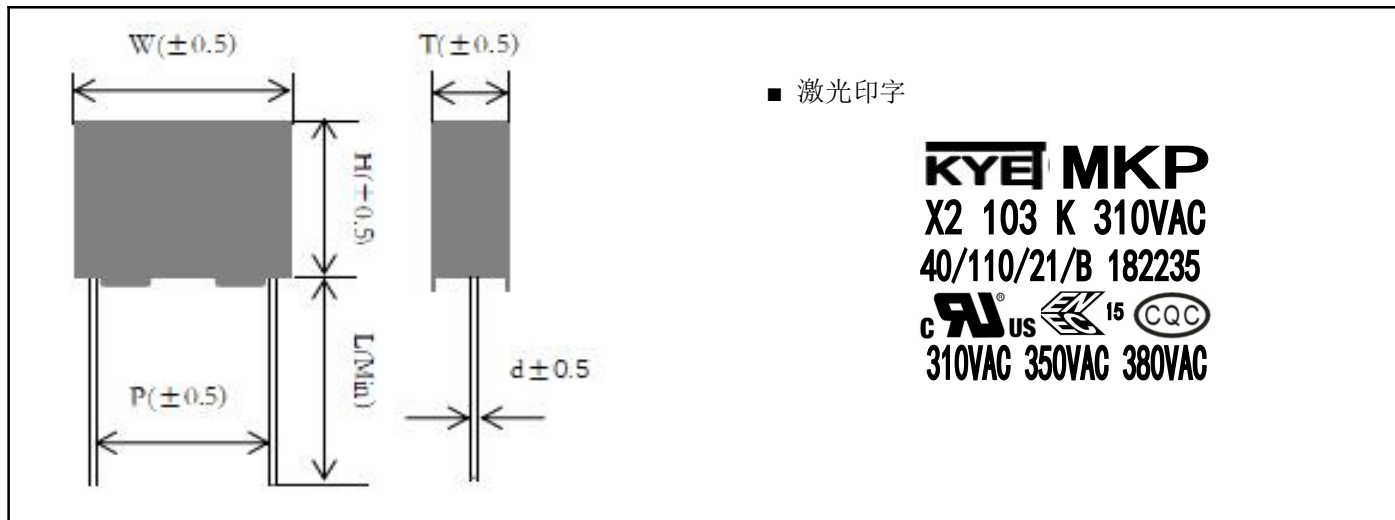

客户产品料号 CUSTOMER P/N	容值 CAP. (μ F)	规格 Symbol	误差 Tol. $\pm\%$	电压 R.V. (VAC)	尺寸毫米为单位 Dimensions in mm						测试 电压 VDC	科雅产品型号 KEYA P/N
					宽 W ± 0.5 mm	高 H ± 0.5 mm	厚 T ± 0.5 mm	脚距 P ± 0.5 mm	线径 ϕd ± 0.05	脚长 L ± 2		
PX103K2C1003	0.01	103	10	310VAC	13	11	5	10	0.6	20	1333	PX103K2C1003

PX103K2C1003

① 产品类别 Type of capacitor

类别 model	MPP	MPR	CBB21	CBB22	MER	CL21	PPS	CBB81	CBB28	PPN	CBB13	X2	MPB
代码 Code	KP	KP	KP	KP	PE	PE	PS	PS	PS	PN	PN	PX	PC
型号 model													
代码 Code													

② 产品容量代码 Capacitance code (EIA Code)

代码 Code	容量换算 Capacitance			代码 Code	容量换算 Capacitance			代码 Code	容量换算 Capacitance		
101	100pF	0.1nF	0.0001uF	103	10,000pF	10nF	0.01uF	105	1,000,000pF	1,000nF	1uF
102	1,000pF	1nF	0.001uF	104	100,000pF	100nF	0.1uF	106	10,000,000pF	10,000nF	10uF

③ 产品容量误差 Tolerance (EIA Code)

误差 Tol.	±1%	±2%	±3%	±5%	±10%	±20%	-10%~0%	0%~+10%	-5%~+10%	-10%~+5%	0%~+20%
代码 Code	F	G	I	J	K	M	L	P	U	V	W

④ 产品额定电压 Rated Voltage

电压 Voltage	63	100	125	250	275	310	350	380	400	450	630	800	1000	1200	1250	1600	2000	3000
代码 Code	1J	2A	2B	2E	2C	2C	2W	2w	2G	2K	2J	2D	3A	3I	3B	3C	3F	3G

⑤ 产品本体脚距 Lead Space

本体脚距 Lead Space	5	7.5	10	15	20	22.5	24	25	26	27.5	31
代码 Code	05	07	10	15	20	22	24	25	26	27	31

⑥ 辅助码(内部识别码) Accessories Yards

NO.	说明 Descriptions
1	每个规格第一料号时用“01” Each specification first edit with "01"
2	同种规格原料、外观及尺寸有差异时用“01, 02, 03. . .”进行区分 The same specifications appearance and size differ with non-simultaneous 01, 02, 03 to distinguish

Guideline of notabilia for the usage of plastic film capacitors

塑胶薄膜电容器的使用上注意事项及指导

Plastic film capacitors use organic films for their dielectrics, thus the capacitors may fume of flame, depending on the circuit conditions they are in, when they are damaged by applying over-voltage or over-current.

塑胶薄膜电容器使用有机薄膜为介质，当使用超过额定电压及额定电流，可能产生火焰，导致电容损坏，故请使用于正确的电路。

1. Circuit Design 电路设计

- Please use capacitors within the range of their characteristic ratings, only after confirming their operating and mounting environments.
请确认电容器的使用范围仅止于明定之额定特性规范，请先确认电容器使用之环境是否符合规范。
- In case of selecting a capacitor, please select the most suitable one which fits to your operating conditions.
请依照适合的作业条件选择相对应的电容器使用。
- An applying voltage to a capacitor, including the peak of surge and ripple voltage (D.C. voltage + A.C. Peak), cannot be exceeded the rating voltage.
电容器之应用电压，包括突波和纹波电压的峰值(直流电压+交流峰值)不可超过额定电压。
- Do not apply a current over its permissible level. Also, make sure the check the surrounding temperature and inherent temperature rise of a capacitor since a permissible current can be restricted by those factors.
切勿使用超出电容器可承载之电流并检查电容器周围之温度，因有许多因素会影响电流之变化，进而造成电容器之温度上升。
- Do not conduct a rapid charge and discharge to a capacitor which may lead to characteristics degradations or break down of the capacitor.
请不要对电容器进行快速的充电和放电，此可能会导致电容器之特性退化或损坏。

2. Mounting 安装

- Do not apply any exceeding tension or torsion to lead wires of a capacitor, during the mounting process.
请不要使用任何超过电容导线可承受之张力进行插件。
- Please mount a capacitor where it dose not contact any other heating parts, high voltage parts and other parts.
请确认电容器使用环境，避免接触任何其他升温热物件,高压和其他部分料件。
- Please conduct soldering process by strictly following the specified conditions.
进行焊接过程时，请严格遵循指定之焊接条件。

3. Storing and handling 储存和处理

- A storage needs to be kept indoors at -10~+30°C and relative humidity of under 75% without any sudden temperature changes, direct sunlight and corrosive gas around.
需保存于-10 ~ 30°C，相对湿度低于75%并确保没有任何突然的温度变化，避免直接阳光之曝晒及接触腐蚀性气体之环境。
- Do not apply and exceeding vibration, shock (dropping) and pressure.
不应过度震动、碰撞和及外力的冲击。

NO.	项目 ITEM	说明 DESCRIPTIONS
1	承认范围 SCOPE	本规格适用于科雅之要求 This specifications cover the requirements of KYET 金属化聚丙烯薄膜 Metallized Polypropylene Film 交流电容器 (抑制电源电磁干扰用固定电容器) 等级-X2 AC Capacitor (Interference Suppressors Class-X2).
2	各测量皆于标准大气下进行 STANDARD ATMOSPHERIC CONDITIONS FOR MAKING MEASUREMENTS	
2.1	环境温度 AMBIENT TEMPERATURE	15°C 至 35°C (如对结果有任何疑问, 该测量环境温度应为+20 ± 5°C之间) 15°C to 35°C (If there is any doubt on the results, the measurements shall be made at +20 ± 5°C)
2.2	相对湿度 RELATIVE HUMIDITY(R.H.)	45%至 75% (如对结果有任何疑问, 该测量相对湿度应为 60% to 70%之间) 45%to 75% (If there is any doubt on the results, the measurements shall be made at 60% to 70%)
2.3	大气压力 AIR PRESSURE	86 千帕至 106 千帕之 86 kpa to 106 kpa
2.4	工作温度范围 OPERATING TEMPERATURE RANGE	于-40°C至+110°C间, 电容可在额定电压下持续运作 -40°C to +110°C for which the capacitor can be operated continuously at rated voltage.
3	结构 CONSTRUCTION	
3.1	电介质 DIELECTRIC	金属化聚丙烯薄膜 Metallized Polypropylene Film
3.2	喷金层 METAL SPRAY	锌锡合金 Special Solder
3.3	导线 LEAD WIRE	镀锡铜包钢线 Copper-clad Steel Wire
3.4	环氧树脂 EPOXY RESIN	V-0 阻燃等级
3.5	塑料外壳 PLASTIC CASE	V-0 阻燃等级
		
4	打印 MARKING	
4.1	制造商标志 MANUFACTURER'S SYMBOL	 表示为“科雅电子有限公司 KYET ELECTRONICS CO., LTD”
4.2	型号或材质 TYPE OR MATERIAL	“MKP”代表“X2”类型 “MKP” stands for “X2” type
4.3	电容类别 CAPACITOR CLASS	“X2”代表“X2”等级 “X2stands for “X2” class
4.4	静电容量 NOMINAL CAPACITANCE	容量用 EIA 三码表示 Capacitance Expressed in 3-digit (EIA) code.
4.5	容量容许差值 TOLERANCE	J (±5%), K (±10%), M (±20%)
4.6	额定电压 RATED VOLTAGE	交流电压 310-350-380V in VAC rating. (50/60Hz)
4.7	电容气候类别 CLIMATIC CATEGORY	40/110/21/B
4.8	国际认证 APPROVAL MARKS	cULus / ENEC / CQC
.9	制造番号 MANUFACTURE CODE	182235--2018 年第 2235 制造批次

范例 example

KYE MKP
X2 103 K 310VAC
40/110/21/B 182235

310VAC 350VAC 380VAC

5 电气特性 ELECTRICAL CHARACTERISTICS				
NO.	项目 ITEM		说明 DESCRIPTIONS	
5.1	耐压 (TV) Withstand Voltage	端子之间 Between Terminals	应无异常 Shall be no abnormality 非标准小型化产品施加 1.5-2 倍额定直流电压, 测试 60 秒 Non-standard miniaturized products apply 1.5-2 times rated DC voltage for 60 seconds	施加 4.3 倍额定直流电压测试 60 秒(电压应以不超过 150V/s 的速率从零升高到试验电压, 时间应从达到电压时计算, 在结束时, 电压应减少到接近零, 并且电容器应通过一个适当的电阻放电) Apply 4.3*Ur (DC) for 60 sec (Should be no more than 150V/s rate increased from zero to the test voltage, testing time, meets the test voltage should be calculated at the end of the trial, the voltage should be reduced to zero and the capacitor through a resistor of appropriate discharge.
		端子与外壳之间 Between Terminals & Enclosure	应无异常 Shall be no abnormality	2 倍额定电压+1,500VAC, 测试 2 到 5 秒 最小值 2,000VAC Apply 2*Ur+1,500VAC for 2 to 5 sec. Min. 2,000VAC
5.2	介质损耗 (DF) Dissipation Factor		于 1KHz 时 $\leq 0.001(0.1\%)$ $\leq 0.001(0.1\%)$ at 1 KHz	测量频率: $\pm 2\%$; 测量电压: ≤ 1 rms Measuring Frequency: $\pm 2\%$ Measuring Voltage: ≤ 1 Vrms..
5.3	容量 (CAP) Capacitance		偏差值如标示(于 $+20 \pm 5^\circ\text{C}$)。 Within the tolerance specified (at $+20 \pm 5^\circ\text{C}$).	测量频率: $\pm 2\%$; 测量电压: ≤ 1 rms Measuring Frequency: $\pm 2\%$ Measuring Voltage: ≤ 1 Vrms..
5.4	绝缘电阻 (I.R.) Insulation Resistance		$\geq 15,000$ Mohm ($C \leq 0.33\mu\text{f}$) 容值 $\leq 0.33\mu\text{f}$ 时, 绝缘电阻 $\geq 15,000\text{M}\Omega$ $\geq 5,000$ Mohm* $\mu\text{F}/\text{C}$ ($C > 0.33\mu\text{f}$) 容值 $> 0.33\mu\text{f}$ 时, 绝缘电阻 $\geq 5,000\text{M}\Omega * \mu\text{F} / \text{C}$	应加电压 100 伏 充电时间 60 \pm 5 秒。 Vt=100 VDC Charge Time : 60 \pm 5 sec.
5.5	焊料附着性 Soldering Property		焊料覆盖面积应超过导线表面圆周 90%。 More than 90% of circumferential surface of lead wire shall be covered with new solder.	焊接温度为: $+265 \pm 5^\circ\text{C}$ 浸焊时间为: 3 ± 0.5 秒 Soldering temperature: $+265 \pm 5^\circ\text{C}$ Immersion duration: 3 ± 0.5 sec.
6 机械特性 MECHANICAL CHARACTERISTICS				
6.1	端子强度 Terminal Strength	引张强度 Tensile Strength	应无异常。 Shall be no abnormality	沿着轴向和引出方向, 施加 1 公斤力量, 保持 10 \pm 1 秒。 Apply 1.0Kg for 10 \pm 1 sec. to the terminal in the axial direction and acting in a direction away from the body.





7 耐久性特性 ENDURANCE CHARACTERISTICS				
NO.	项目 ITEM		说明 DESCRIPTIONS	
7.1	温度变化循环 Temperature Cycle	外观 Appearance	应当无显著变化 Shall be no remarkable change	共 5 次温度循环测试, 循环条件: 1. +20 ± 2°C 持续 3 分钟 2. -40 ± 3°C 持续 30 分钟 3. +20 ± 2°C 持续 3 分钟 4. +110 ± 2°C 持续 30 分钟 5. +20 ± 2°C 持续 3 分钟 试验后放置于室内 1.5 ± 0.5 小时后再进行量测。 Test Temperature Cycle: Total 5 cycles. Each cycle includes 1. 20 ± 2°C for 3 min. 2. -40 ± 3°C for 30 min. 3. +20 ± 2°C for 3 min. 4. +110 ± 2°C for 30 min. 5. +20 ± 2°C for 3 min. After test, allow it stay alone for 1.5 ± 0.5 Hrs. at ordinary condition before making measurements.
		耐压 Withstand Voltage	应满足 NO.5.1 shall satisfy NO.5.1	
		容值变化率 ($\Delta C/C$) Capacitance Change Rate	变化率小于 ±5% Within ±5% of the value before test	
		介质损耗 Dissipation Factor	于 1KHz 时: 最大值为 0.002 (0.2%) @ 1KHz: 0.002 (0.2%) max.	
		绝缘电阻 (I.R.) Insulation Resistance	≥50%的限制值在 NO.5.4 ≥50% of the limit value of NO.5.4	
7.2	耐干热试验 Dry Heat Resistance	外观 Appearance	应当无显著变化 Shall be no remarkable change	试验温度: +110 ± 2°C 测试时间: 16 + 1/-0 小时 Test Temperature: +110 ± 2°C Test Duration: 16 + 1/-0 hrs.
		耐压 Withstand Voltage	应满足 NO.5.1 Shall satisfy NO.5.1	
		容值变化率 ($\Delta C/C$) Capacitance Change Rate	变化率小于 ±5% Within ±5% of the value before test	
		介质损耗 Dissipation Factor	于 1KHz 时: 最大值为 0.002 (0.2%) @ 1KHz: 0.002 (0.2%) max.	
		绝缘电阻 (I.R.) Insulation Resistance	≥50%的限制值在 NO.5.4 ≥50% of the limit value of NO.5.4	
7.3	耐干寒试验 Cold Resistance	外观 Appearance	应当无显著变化 Shall be no remarkable change	试验温度: -40 ± 3°C 测试时间: 2 ± 1 小时 Test Temperature: -40 ± 3°C Test Duration: 2 ± 1 hrs.
		耐压 Withstand Voltage	应满足 NO.5.1 Shall satisfy NO.5.1	
		容值变化率 ($\Delta C/C$) Capacitance Change Rate	变化率小于 ±5% Within ±5% of the value before test	
		介质损耗 Dissipation Factor	于 1KHz 时: 最大值为 0.002 (0.2%) @ 1KHz: 0.002 (0.2%) max.	
		绝缘电阻 (I.R.) Insulation Resistance	≥50%的限制值在 NO.5.4 ≥50% of the limit value of NO.5.4	

NO.	项目 ITEM	说明 DESCRIPTIONS	
7.4	耐湿绝缘 Damp Heat	外观 Appearance	应当无显著变化 Shall be no remarkable change
		耐压 Withstand Voltage	应满足 NO.5.1 Shall satisfy NO.5.1
		容值变化率 ($\Delta C/C$) Capacitance Change Rate	变化率小于 $\pm 5\%$ Within $\pm 5\%$ of the value before test
		介质损耗 Dissipation Factor	于 1KHz 时: 最大值为 0.002 (0.2%) @ 1KHz: 0.002 (0.2%) max.
		绝缘电阻 (I.R.) Insulation Resistance	$\geq 50\%$ 的限制值在 NO.5.4 $\geq 50\%$ of the limit value of NO.5.4
7.5	振动试验 Vibration Resistance	外观 Appearance	应无机械性损伤 Shall be no mechanical damage.
		连接强度 Connection strength	不得为短路或开路连接。 连接点应稳定。 Shall be no short-circuiting or open. The connection shall be stable.
7.6	焊接耐热 Soldering Heat Resistance	外观 Appearance	应当无显著变化 印字标志应清晰 Shall be no remarkable change. The marking shall be legible.
		端子间的耐电压值 Withstand Voltage Between Terminals	应满足 NO.5.1 Shall satisfy NO.5.1
		容值变化率 ($\Delta C/C$) Capacitance Change Rate	变化率小于 $\pm 5\%$ Within $\pm 5\%$ of the value before test
		介质损耗 Dissipation Factor	于 1KHz 时: 最大值为 0.002 (0.2%) @ 1KHz: 0.002 (0.2%) max.
		绝缘电阻 (I.R.) Insulation Resistance	$\geq 50\%$ 的限制值在 NO.5.4 $\geq 50\%$ of the limit value of NO.5.4
		连接元件 Connection of Element	应稳定 Shall be stable
			试验温度: $+40 \pm 2^\circ\text{C}$ 试验湿度: 90%至 95%相对湿度 试验时间: 21 天 试验后放置于室内 1.5 ± 0.5 小时后再进行量测。 Test Temperature: $+40 \pm 2^\circ\text{C}$. Test Humidity: 90% to 95% R.H. Test Duration: 21 days. After test, allow it stay alone for 1.5 ± 0.5 Hrs. at ordinary condition before making measurements.
			频率变化: 10-55-10Hz 振动距离: 1.5 毫米. 试验方向: X,Y,Z 试验时间:每个方向 $2+1/-0$ 小时 Frequency Change : 10-55-10 Hz Vibration Distance:1.5 mm. Test Direction : X,Y,Z Test Duration : $2+1/-0$ hrs each direction
			预热温度: $100 \sim 120^\circ\text{C}$ 预热时间:最大为 60 秒 温度升高:最大为 $3^\circ\text{C}/\text{秒}$ 锡炉温度: $+260 \pm 5^\circ\text{C}$ 浸焊时间: 3 ± 1 秒 浸焊深度:导线根部 4 ± 0.8 毫米 试验后放置于室内 1.5 ± 0.5 小时后再进行量测。 Preheat Temp. : $100 \sim 120^\circ\text{C}$ Preheat Duration : 60 sec. max. Temperature Increase by $3^\circ\text{C}/\text{sec}$. max. Soldering Temperature : $+260 \pm 5^\circ\text{C}$ Immersion Duration : 3 ± 1 sec. Immersion Depth : 4 ± 0.8 mm from roots. After test, allow it stay alone for 1.5 ± 0.5 Hrs. at ordinary condition before making measurements.

NO.	项目 ITEM	性能 PERFORMANCE	测试条件 TEST CONDITIONS
7.7	耐久寿命 Endurance	外观 Appearance	应当无显著变化 Shall be no remarkable change
		耐压 Withstand Voltage	应满足 NO.5.1 Shall satisfy NO.5.1
		容值变化率 ($\Delta C/C$) Capacitance Change Rate	变化率小于 $\pm 10\%$ Within $\pm 10\%$ of the value before test
		介质损耗 Dissipation Factor	于 1KHz 时: 最大值为 @ 1KHz Cr $\leq 1\mu F$: 0.008 (0.8%) max. Cr $> 1\mu F$: 0.005 (0.5%) max.
		绝缘电阻 (I.R.) Insulation Resistance	$\geq 50\%$ 的限制值在 NO.5.4 $\geq 50\%$ of the limit value of NO.5.4
试验温度: $+110 \pm 2^\circ C$ 测试电压: 1.25 倍的额定电压 试验时间: 1,000 小时 每小时将电压升至 1,000VAC, 持续 0.1 秒 每个电容分别通过一个 $47\Omega \pm 5\%$ 电阻。 Test Temperature: $+110 \pm 2^\circ C$ Test Voltage: 125% * rated voltage. Test Duration: 1,000 Hrs. Once every hour the voltage is increased to 1000 V rms. For 0.1 sec. The test voltage is applied to each capacitor individually through a resistor of $47\Omega \pm 5\%$.			
7.8	高温高湿 High temperature High humidity	外觀 Appearance	應當無顯著變化 Shall be no remarkable change
		耐壓 Withstand Voltage	應滿足 NO.5.1 Shall satisfy NO.5.1
		容值變化率 ($\Delta C/C$) Capacitance Change Rate	變化率小於 $\pm 5\%$ Within $\pm 5\%$ of the value before test
		介質損耗 Dissipation Factor	於 1KHz 時: 最大值为 0.002 (0.2%) @ 1KHz: 0.002 (0.2%) max.
		絕緣電阻 (I.R.) Insulation Resistance	$\geq 50\%$ 的限制值在 NO.5.4 $\geq 50\%$ of the limit value of NO.5.4
試驗溫度: $+85 \pm 2^\circ C$. 試驗濕度: $85\% \pm 2\%$ 相對濕度 測試電壓: 240VAC 試驗時間: 1000 小時 試驗後放置於室內 1.5 ± 0.5 小時後再進行量測。 Test Temperature: $+40 \pm 2^\circ C$. Test Humidity: $85\% \pm 2\%$ R.H. Test Voltage: 240VAC Test Duration: 1000 Hrs. After test, allow it stay alone for 1.5 ± 0.5 Hrs. at ordinary condition before making measurements.			

产品安规认证

PRODUCT SAFETY APPROVALS

标志 Mark	认证单位 Agent	应用标准 Standard	规格范围 Specification	证书号码 Certificate No.
	美国 / 加拿大 UL / CUL	UL EN 60384-14:2013 (AMD2016) CSA E60384-14	X2, 310/ 350/380 VAC 0.001 μF to 4.7 μF	E502709
	欧盟 ENEC	EN 60384-14:2013 (AMD2016)	X2, 310/ 350/380 VAC 0.001 μF to 4.7 μF	ENEC-02253-M1
	中国 CQC	IEC 60384-14: 2005 GB/T 6346.14-2015	X2, 310/ 350/380 VAC 0.001 μF to 4.7 μF	CQC18001207926
	IECEE	IEC 60384-14: 2005 GB/T 6346.14-2015	X2, 310/ 350/380 VAC 0.001 μF to 4.7 μF	CN44127

薄膜电容性能参数 Electrical Characteristics of Film Capacitor

1. 焊接温度与时间对比

Soldering Temperature VS Time

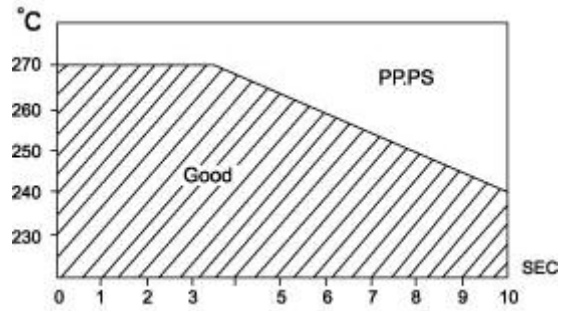
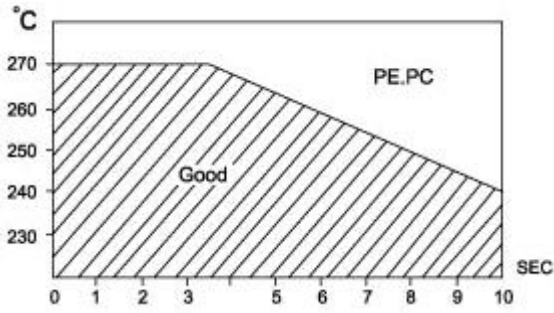

2. 温度性能

Temperature Characteristic

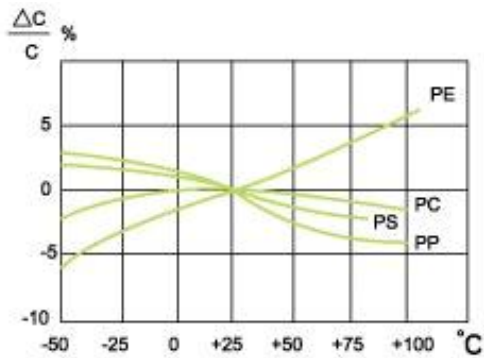

容量变化率与温度的关系

Capacitance vs. Temperature

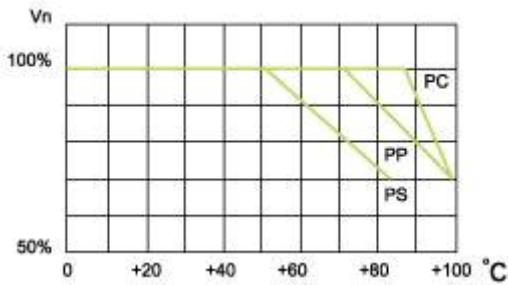

使用电压与温度的关系

Operation voltage vs. Temperature

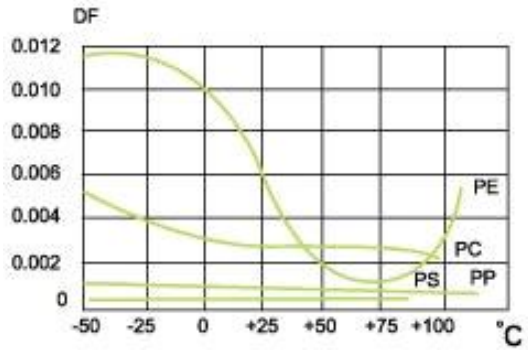

损耗角正切与温度的关系

Dissipation Factor vs. Temperature

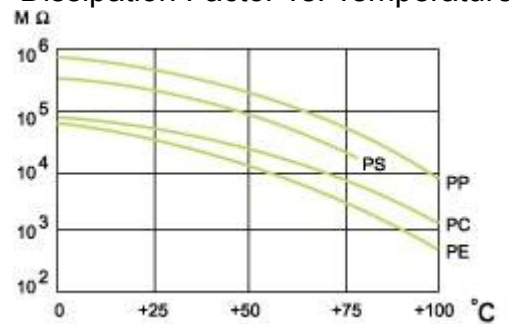

绝缘电阻与温度的关系

(CR value) IR vs. Temperature

3. 频率性能

Frequency Characteristics

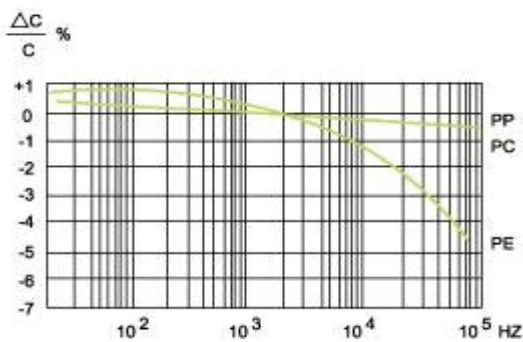

容量变化率与频率的关系

Capacitance vs. Frequency

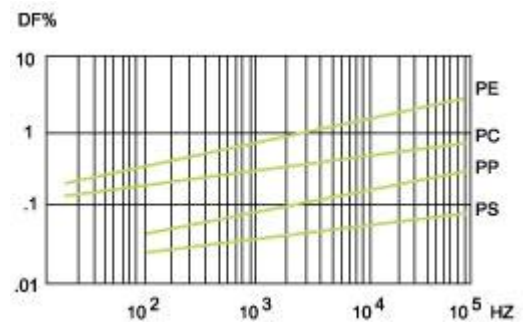

损耗角正切与频率的关系

Dissipation Factor vs. Frequency

焊接温度：

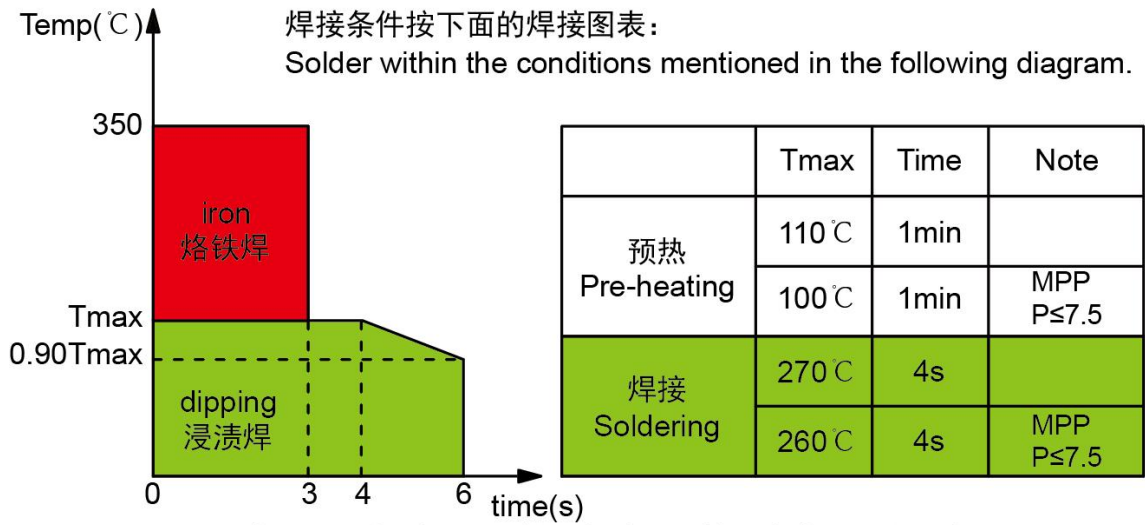

如果需要焊接两次，第二焊接必须等到电容器恢复到常温。

If re-working or dipping twice in necessary, it should be done after the capacitor returned to the normal temperature.

注意事项：薄膜电容器不适合回流焊焊接，否则产品会因热收缩导致性能问题。

● 贮存条件和时间：

1. 贮存温度及湿度：-10~40℃，25~75%RH
2. 贮存时间： 一年